

N-channel 200 V, 0.29 Ω typ., 9 A, STripFET™ Power MOSFET in a TO-220 package

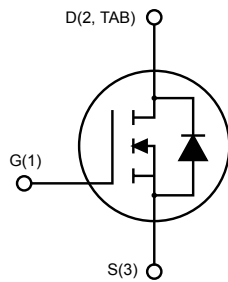

Product status link

[IRF630](#)

Product summary

Order code	IRF630
Marking	IRF630
Package	TO-220
Packing	Tube

Features

Order code	V_{DS}	$R_{DS(on)}$ max.	I_D
IRF630	200 V	0.40 Ω	9 A

- Extremely high dv/dt capability
- Very low intrinsic capacitance
- Gate charge minimized

Applications

- Switching applications

Description

This Power MOSFET series realized with STMicroelectronics unique STripFET™ process has specifically been designed to minimize input capacitance and gate charge. It is therefore suitable as primary switch in advanced high-efficiency isolated DC-DC converters.

1 Electrical ratings

Table 1. Absolute maximum ratings

Symbol	Parameter	Value	Unit
V_{DDS}	Drain-source voltage ($V_{\text{GS}} = 0 \text{ V}$)	200	V
V_{DGR}	Drain-gate voltage ($R_{\text{GS}} = 20 \text{ k}\Omega$)	200	V
V_{GS}	Gate-source voltage	± 20	V
I_{D}	Drain current (continuous) at $T_{\text{C}} = 25 \text{ }^\circ\text{C}$	9	A
	Drain current (continuous) at $T_{\text{C}} = 100 \text{ }^\circ\text{C}$	6.5	A
$I_{\text{DM}}^{(1)}$	Drain current (pulsed)	36	A
P_{TOT}	Total power dissipation at $T_{\text{C}} = 25 \text{ }^\circ\text{C}$	120	W
$E_{\text{AS}}^{(2)}$	Single pulse avalanche energy	110	mJ
$dv/dt^{(3)}$	Drain-body diode dynamic dv/dt ruggedness	5.8	V/ns
T_{stg}	Storage temperature range	-65 to 175	$^\circ\text{C}$
T_{J}	Operating junction temperature range		

- Pulse width is limited by safe operating area.*
- Starting $T_{\text{J}} = 25 \text{ }^\circ\text{C}$, $I_{\text{D}} = 4.5 \text{ A}$*
- $I_{\text{SD}} = 9 \text{ A}$, $di/dt = 520 \text{ A}/\mu\text{s}$, $V_{\text{DD}} = 50 \text{ V}$, $T_{\text{J}} < T_{\text{Jmax}}$*

Table 2. Thermal data

Symbol	Parameter	Value	Unit
$R_{\text{thj-case}}$	Thermal resistance junction-case	1.26	$^\circ\text{C}/\text{W}$
$R_{\text{thj-amb}}$	Thermal resistance junction-ambient	62.5	$^\circ\text{C}/\text{W}$

2 Electrical characteristics

$T_{CASE} = 25\text{ °C}$ unless otherwise specified

Table 3. On/off states

Symbol	Parameter	Test conditions	Min.	Typ.	Max.	Unit
$V_{(BR)DSS}$	Drain-source breakdown voltage	$V_{GS} = 0\text{ V}, I_D = 250\text{ }\mu\text{A}$	200			V
I_{DSS}	Zero gate voltage drain current	$V_{GS} = 0\text{ V}, V_{DS} = 200\text{ V}$			1	μA
		$V_{GS} = 0\text{ V}, V_{DS} = 200\text{ V}, T_C = 125\text{ °C}^{(1)}$			100	μA
I_{GSS}	Gate body leakage current	$V_{DS} = 0\text{ V}, V_{GS} = 20\text{ V}$			± 100	nA
$V_{GS(th)}$	Gate threshold voltage	$V_{DS} = V_{GS}, I_D = 250\text{ }\mu\text{A}$	2	3	4	V
$R_{DS(on)}$	Static drain-source on-resistance	$V_{GS} = 10\text{ V}, I_D = 4.5\text{ A}$		0.29	0.40	Ω

1. Defined by design, not subject to production test.

Table 4. Dynamic

Symbol	Parameter	Test conditions	Min.	Typ.	Max.	Unit
C_{iss}	Input capacitance	$V_{DS} = 25\text{ V}, f = 1\text{ MHz}, V_{GS} = 0\text{ V}$	-	370	-	pF
C_{oss}	Output capacitance		-	77	-	pF
C_{rss}	Reverse transfer capacitance		-	14	-	pF
Q_g	Total gate charge	$V_{DD} = 160\text{ V}, I_D = 9\text{ A}$	-	11.6	-	nC
Q_{gs}	Gate-source charge	$V_{GS} = 0\text{ to }10\text{ V}$	-	2.2	-	nC
Q_{gd}	Gate-drain charge	(see Figure 13. Test circuit for gate charge behavior)	-	5.5	-	nC

Table 5. Switching times

Symbol	Parameter	Test conditions	Min.	Typ.	Max.	Unit
$t_{d(on)}$	Turn-on delay time	$V_{DD} = 100\text{ V}, I_D = 4.5\text{ A}, R_G = 4.7\text{ }\Omega, V_{GS} = 10\text{ V}$	-	5.6	-	ns
t_r	Rise time	(see Figure 12. Test circuit for resistive load switching times and Figure 17. Switching time waveform)	-	2.6	-	ns

Table 6. Source-drain diode

Symbol	Parameter	Test conditions	Min.	Typ.	Max.	Unit
$V_{SD}^{(1)}$	Forward on voltage	$I_{SD} = 9\text{ A}$, $V_{GS} = 0\text{ V}$	-		1.5	V
t_{rr}	Reverse recovery time	$I_{SD} = 9\text{ A}$, $di/dt = 100\text{ A}/\mu\text{s}$,	-	118.5		ns
Q_{rr}	Reverse recovery charge	$V_{DD} = 50\text{ V}$	-	393		nC
I_{RRM}	Reverse recovery current	(see Figure 17. Switching time waveform)	-	6.6		A

1. Pulsed: pulse duration = 300 μs , duty cycle 1.5%

2.1 Electrical characteristics (curves)

Figure 1. Safe operating area

Figure 2. Thermal impedance

Figure 3. Output characteristics

Figure 4. Transfer characteristics

Figure 5. Gate charge vs gate-source voltage

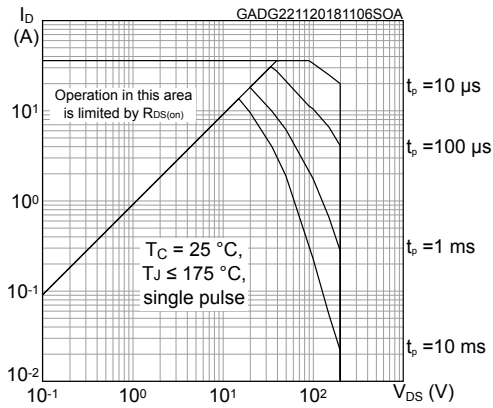
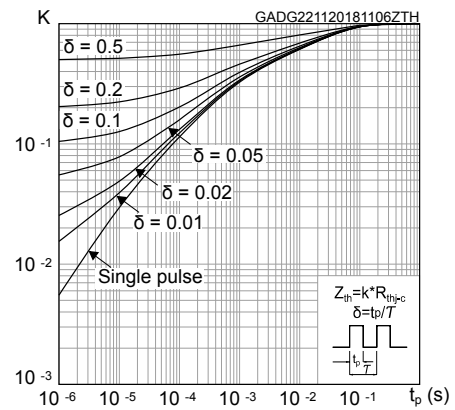
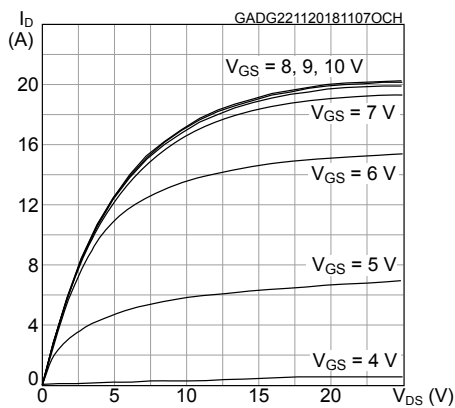
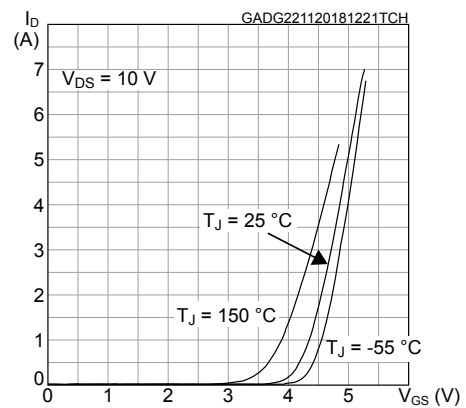
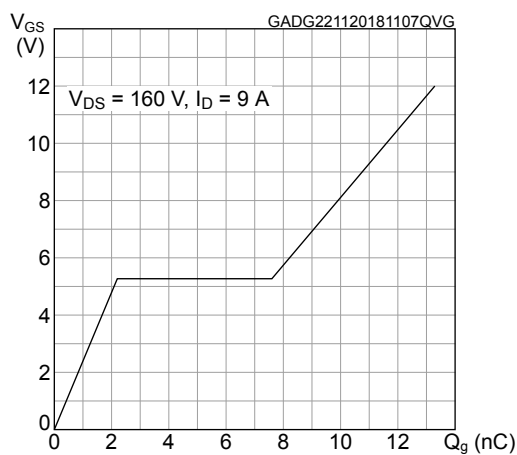
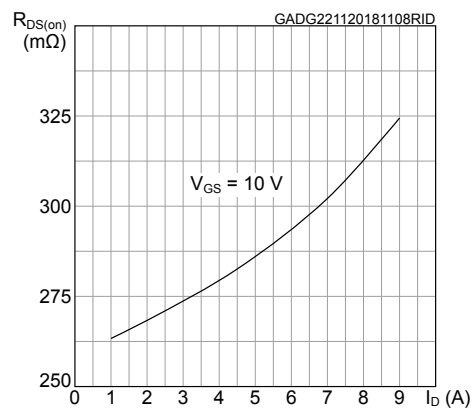
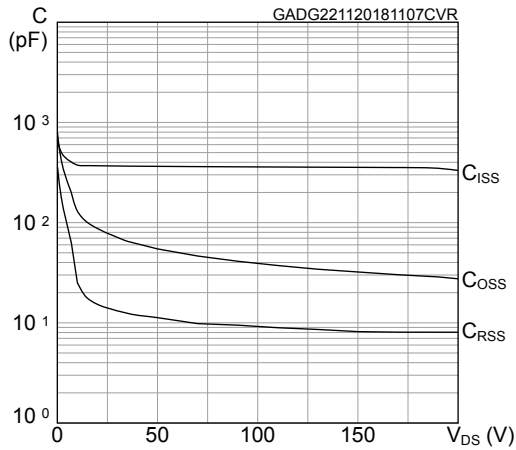
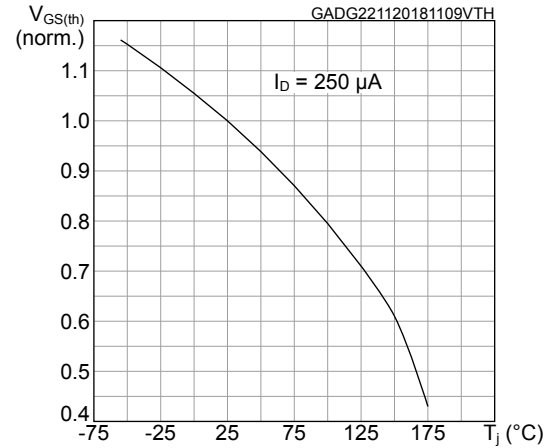
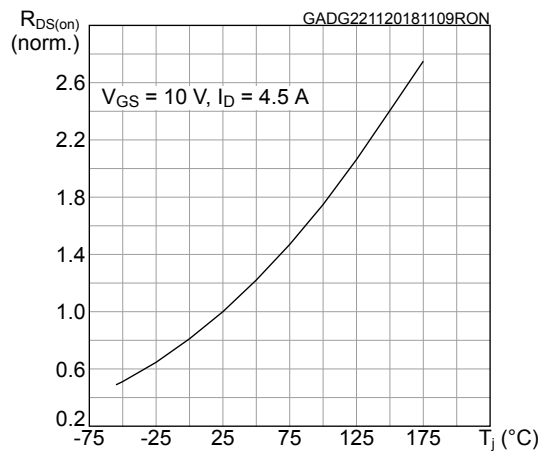
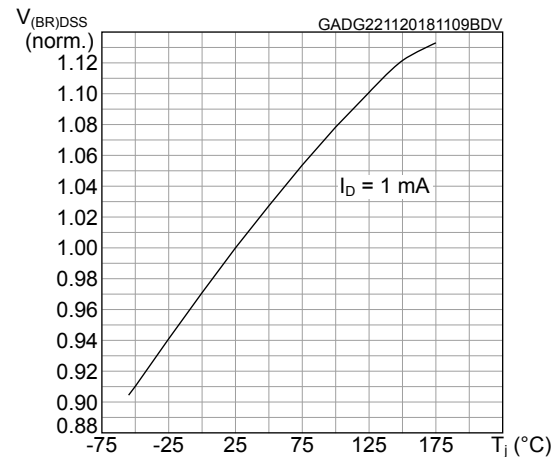
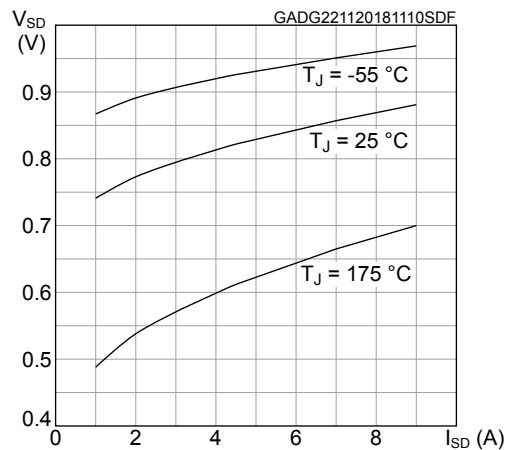
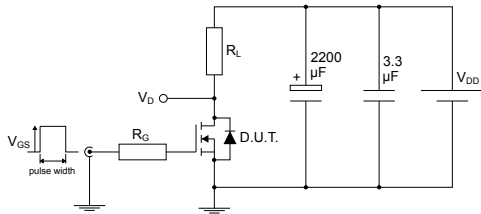
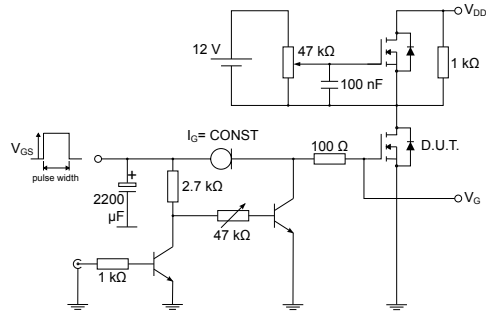
Figure 6. Static drain-source on-resistance

Figure 7. Capacitance variations

Figure 8. Normalized gate threshold voltage vs temperature

Figure 9. Normalized on-resistance vs temperature

Figure 10. Normalized $V_{(BR)DSS}$ vs temperature

Figure 11. Source-drain diode forward characteristics

3 Test circuits

Figure 12. Test circuit for resistive load switching times

AM01468v1

Figure 13. Test circuit for gate charge behavior

AM01469v1

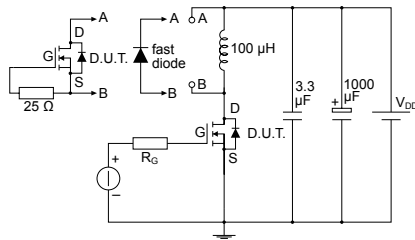
Figure 14. Test circuit for inductive load switching and diode recovery times

AM01470v1

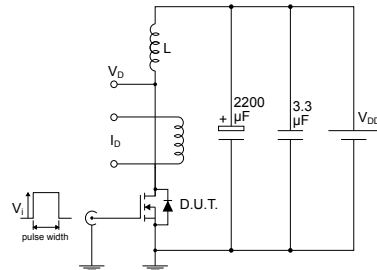
Figure 15. Unclamped inductive load test circuit

AM01471v1

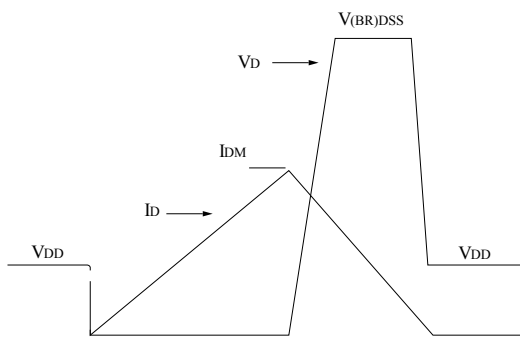
Figure 16. Unclamped inductive waveform

AM01472v1

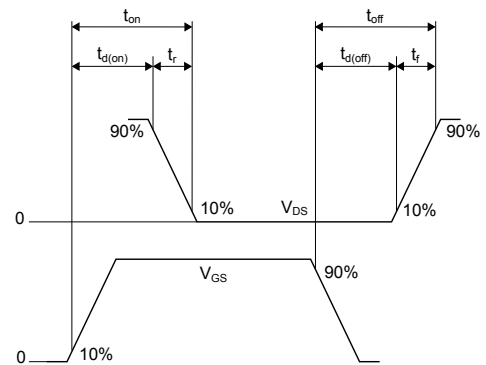
Figure 17. Switching time waveform

AM01473v1

4 Package information

In order to meet environmental requirements, ST offers these devices in different grades of **ECOPACK®** packages, depending on their level of environmental compliance. ECOPACK® specifications, grade definitions and product status are available at: www.st.com. ECOPACK® is an ST trademark.

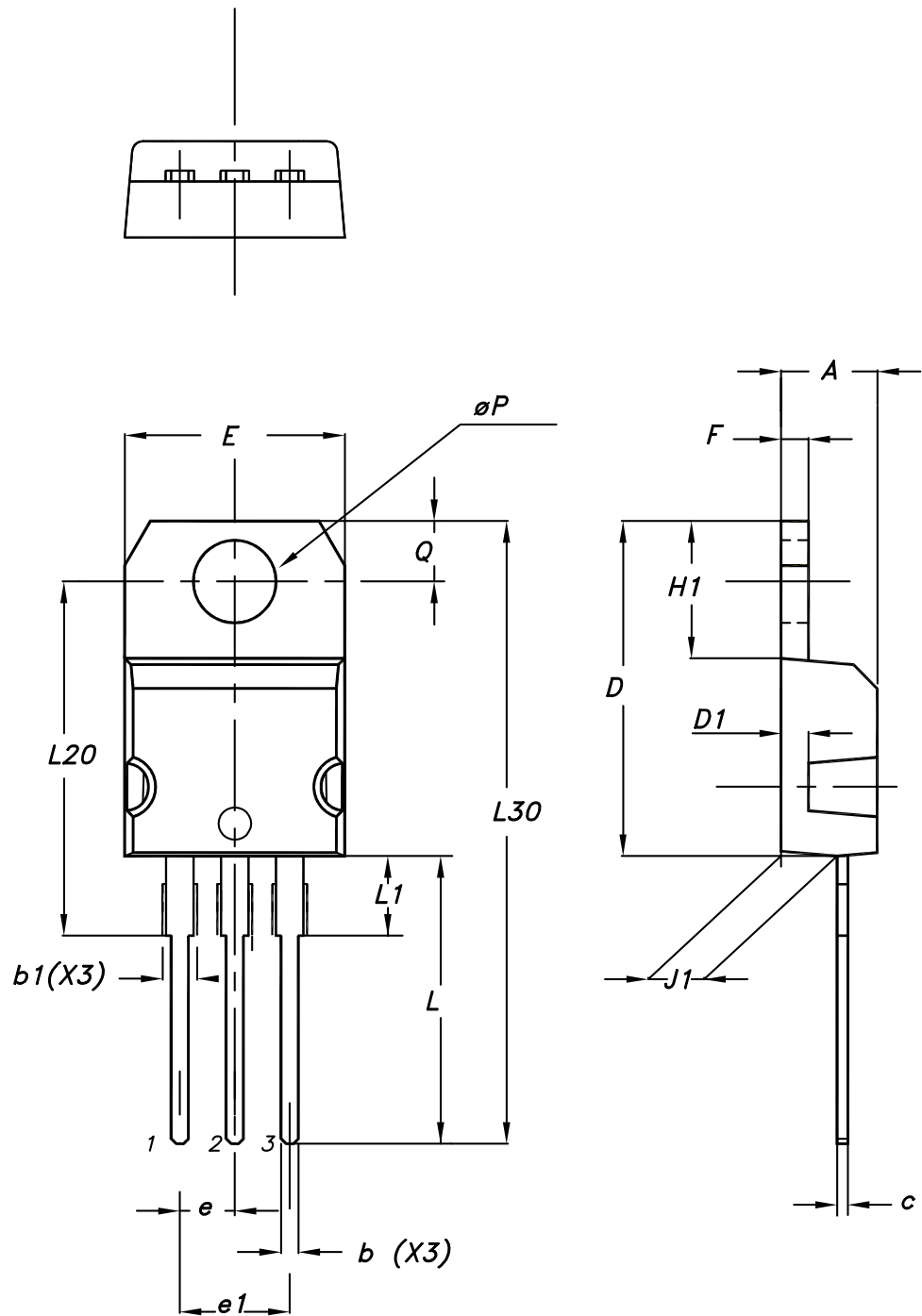
4.1 TO-220 type A package information
Figure 18. TO-220 type A package outline

0015988_typeA_Rev_22

Table 7. TO-220 type A package mechanical data

Dim.	mm		
	Min.	Typ.	Max.
A	4.40		4.60
b	0.61		0.88
b1	1.14		1.55
c	0.48		0.70
D	15.25		15.75
D1		1.27	
E	10.00		10.40
e	2.40		2.70
e1	4.95		5.15
F	1.23		1.32
H1	6.20		6.60
J1	2.40		2.72
L	13.00		14.00
L1	3.50		3.93
L20		16.40	
L30		28.90	
øP	3.75		3.85
Q	2.65		2.95

Revision history

Table 8. Document revision history

Date	Version	Changes
09-Sep-2004	8	Complete version
03-Aug-2006	9	New template, no content change
12-Dec-2018	10	Part number IRF630FP has been moved to a separate datasheet and the document has been updated accordingly. Minor text changes

Contents

1	Electrical ratings	2
2	Electrical characteristics	3
2.1	Electrical characteristics (curves)	5
3	Test circuits	7
4	Package information	8
4.1	TO-220 type A package information	8
	Revision history	11

IMPORTANT NOTICE – PLEASE READ CAREFULLY

STMicroelectronics NV and its subsidiaries (“ST”) reserve the right to make changes, corrections, enhancements, modifications, and improvements to ST products and/or to this document at any time without notice. Purchasers should obtain the latest relevant information on ST products before placing orders. ST products are sold pursuant to ST’s terms and conditions of sale in place at the time of order acknowledgement.

Purchasers are solely responsible for the choice, selection, and use of ST products and ST assumes no liability for application assistance or the design of Purchasers’ products.

No license, express or implied, to any intellectual property right is granted by ST herein.

Resale of ST products with provisions different from the information set forth herein shall void any warranty granted by ST for such product.

ST and the ST logo are trademarks of ST. All other product or service names are the property of their respective owners.

Information in this document supersedes and replaces information previously supplied in any prior versions of this document.

© 2018 STMicroelectronics – All rights reserved

Mouser Electronics

Authorized Distributor

Click to View Pricing, Inventory, Delivery & Lifecycle Information:

[STMicroelectronics:](#)

[IRF630](#)