

# PAJ7620F2: Integrated Gesture Recognition Sensor

## General Description

The PAC7620 integrates gesture recognition function with general I<sup>2</sup>C interface into a single chip forming an image analytic sensor system. It can recognize 9 human hand gesticulations such as moving up, down, left, right, forward, backward, circle-clockwise, circle-counter clockwise, and waving. It also offers built-in proximity detection in sensing approaching or departing object from the sensor. The PAC7620 is designed with great flexibility in power-saving mechanism, well suit for low power battery operated HMI devices. The PAJ7620 is packaged into module form in-built with IR LED and optics lens as a complete sensor solution

## Key Features

- Gesture/Cursor modes
- Built-in proximity detection
- Gesture speed is 60~600°/s in Normal Mode and 60~1200°/s in Gaming Mode
- Flexible power saving scheme
- Communication interface options
- I<sup>2</sup>C (for Gesture/Cursor mode)
- I<sup>2</sup>C interface up to 400 Kbit/s
- Ambient light immunity
- Ambient light noise cancellation

## Applications

- PAD Phone
- Tablet Personal Computer
- Automobile Application

## Key Parameters

Parameter	Value
Array Size	60x60 pixels
Pixel Size	20x20 μm <sup>2</sup>
Max Frame Rate	720 fps @ 240 report rate
Input Clock	N/A
Supply Voltage	VDD: 2.8~3.6V VLED: 3.0~4.2V
Current Consumption	Operation State: 4.6~9.2 mA Standby 1 State: 2.3mA Standby 2 State: 1.5mA
Package Dimensions	7.1x3.5x3.03mm <sup>3</sup>

## Ordering Information

Part Number	Package Type
PAJ7620F2	6-pins FPC Module



For any additional inquiries, please contact us at <http://www.pixart.com/contact.asp>.

**Table of Contents**

**PAJ7620F2: Integrated Gesture Recognition Sensor** ..... 1

    General Description ..... 1

    Key Features ..... 1

    Applications ..... 1

    Key Parameters ..... 1

    Ordering Information ..... 1

**List of Figures** ..... 3

**List of Tables** ..... 3

**1.0 Sensor Overview** ..... 4

    1.1 Gesture Mode ..... 4

    1.2 Architecture Block Diagram ..... 4

    1.3 Signal Description ..... 4

    1.4 Pin Configuration ..... 5

**2.0 Mechanical Specifications** ..... 6

    2.1 Package Dimension ..... 6

    2.2 Recommend Mechanical Design ..... 7

    2.3 Recommended IR Ink Spectrum ..... 9

**3.0 Reference Schematics** ..... 10

**4.0 Sensor Specifications** ..... 11

    4.1 Absolute Maximum Ratings,  $T_A = 27^\circ\text{C}$  ..... 11

    4.2 Recommended Operating Condition ..... 11

    4.3 Electrical Specifications,  $V_{DD}=2.8\text{V}$ ,  $T_A = 27^\circ\text{C}$  ..... 12

    4.4 Gesture Functional Specifications ..... 13

    4.5 Interface AC Specifications ..... 13

**5.0 Register Tables** ..... 14

    5.1 Register Bank Select ..... 14

    5.2 Image Size Setting ..... 14

    5.3 AE/AG Controls ..... 14

    5.4 Interrupt Controls ..... 15

    5.5 Gesture Mode Controls ..... 15

    5.6 Cursor Mode Controls ..... 18

    5.7 Proximity Mode Controls ..... 18

    5.8 EFuse Program Controls ..... 19

    5.9 Background Controls ..... 19

    5.10 Lens Shading Compensation ..... 20

    5.11 LED Controls ..... 20

    5.12 Sleep Mode ..... 20

5.13 Clock Controls..... 21

5.14 Chip/Version ID..... 21

5.15 Suspend/Reset..... 21

5.16 Test Mode ..... 22

5.17 Reserved Registers List..... 22

Document Revision History..... 25

**List of Figures**

Figure 1. Architecture Block Diagram ..... 4

Figure 2. PAJ7620F2 Module Pin Configuration..... 5

Figure 3. PAJ7620F2 Package Outline Diagram..... 6

Figure 4. PAJ7620F2 Mechanical Design Guide ..... 7

Figure 5. PAJ7620F2 Mechanical Design Guide (IR Ink Suggestion)..... 8

Figure 6. IR Ink Spectrum..... 9

Figure 7. PAJ7620F2 Application Circuit..... 10

**List of Tables**

Table 1. Gesture Detecting Range and View Angle ..... 4

Table 2. Signal Description..... 4

Table 3. PAJ7620F2 Pin Definition..... 5

## 1.0 Sensor Overview

### 1.1 Gesture Mode

For Gesture Mode, there are 9 gestures recognition being embedded in the sensor including move up, move down, move left, move right, move forward, move backward, circle-clockwise, circle-counter clockwise, and wave. These gestures information can be simply accessed by register reading via I<sup>2</sup>C bus. The normal gesture detecting range from 5 to 15 cm in Near Mode and 15 to 30 cm in Far Mode from where PAC7620 is located through the operating view angle of diagonally 60° and 30° respectively. Additionally, The PAC7620 can be configured as Normal Mode (Gesture speed is 60°/s - 600°/s) or Gaming Mode (Gesture speed is 60°/s - 1200°/s) for different applications. The PAC7620 also offer built-in proximity detection for the purpose of sensing object approaching or departing.

Table 1. Gesture Detecting Range and View Angle

Part Number	Mode	Detecting Range	View Angle (Diagonal)
PAJ7620F2	Near	5 to 15 cm	60°
	Far	15 to 30cm	30°

### 1.2 Architecture Block Diagram

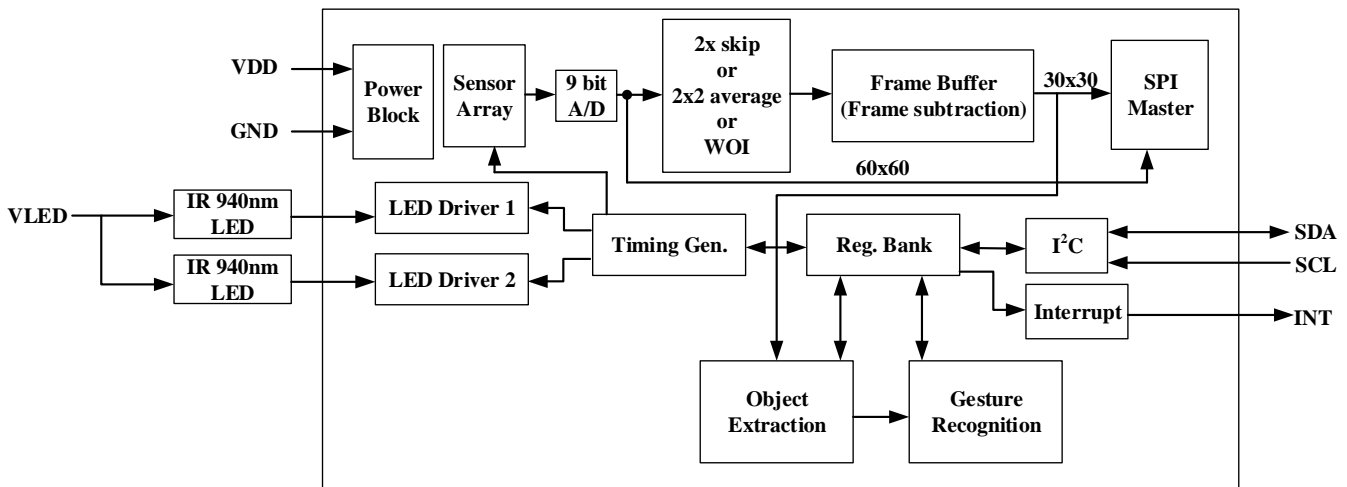

Figure 1. Architecture Block Diagram

### 1.3 Signal Description

Table 2. Signal Description

Signal Name	Description
SDA	I <sup>2</sup> C data pin
SCL	I <sup>2</sup> C clk pin
INT_N	Interrupt pin (Active low) for Gesture Mode.

1.4 Pin Configuration

Table 3. PAJ7620F2 Pin Definition

Pin No.	Symbol	Type	Function
1	V <sub>LED</sub>	POWER	LED power input
2	V <sub>DD</sub>	POWER	Main power supply
3	INT_N	OUT	Interrupt pin (Active low) (Open Drain)
4	SDA	IN/OUT	I <sup>2</sup> C data pin (Open Drain)
5	SCL	IN	I <sup>2</sup> C clock pin (Open Drain)
6	GND	GND	Ground

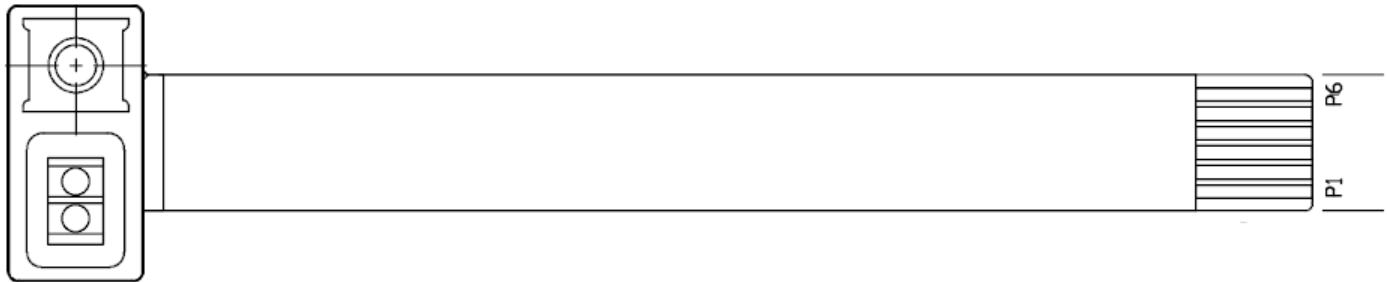

Figure 2. PAJ7620F2 Module Pin Configuration

## 2.0 Mechanical Specifications

### 2.1 Package Dimension

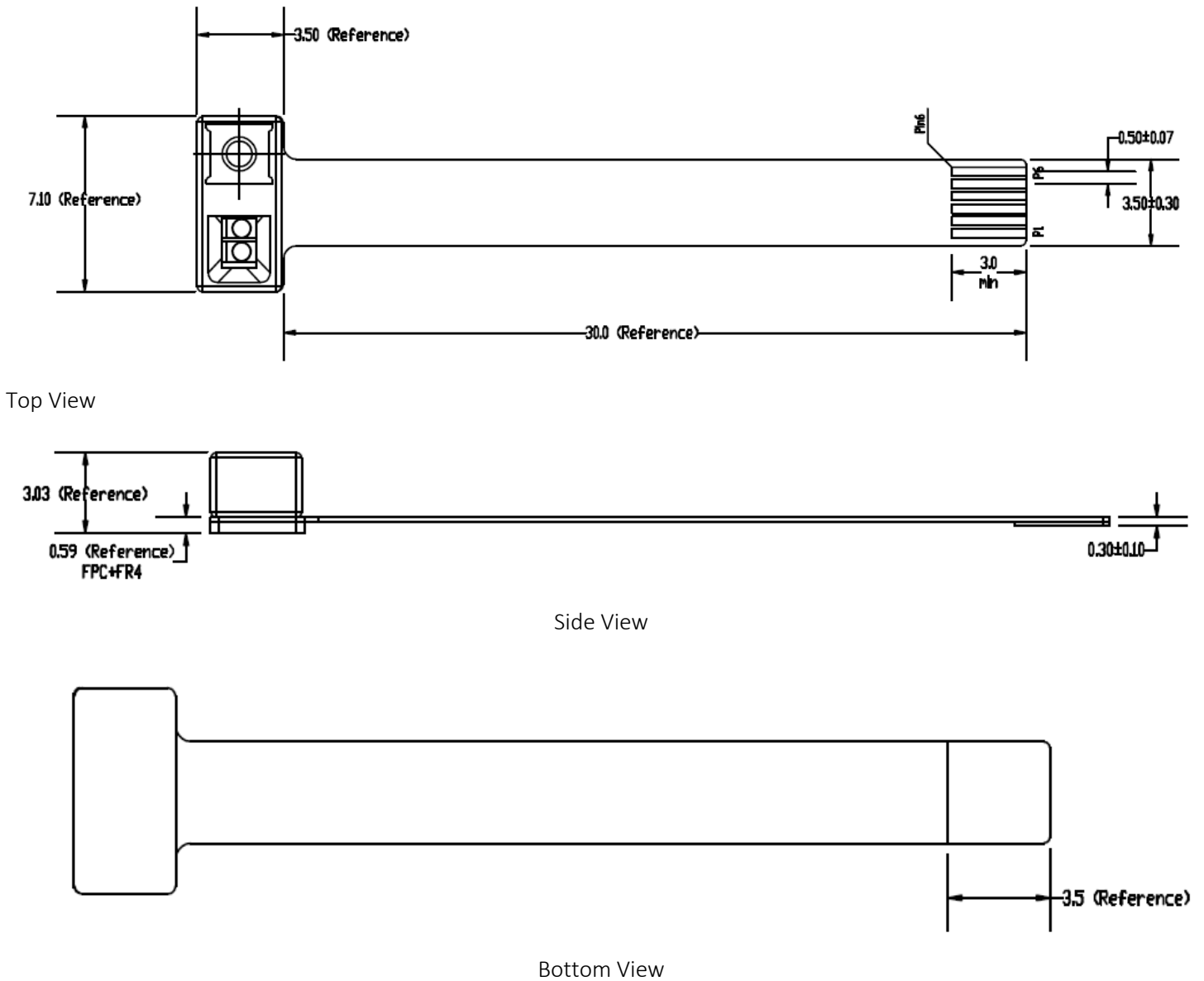
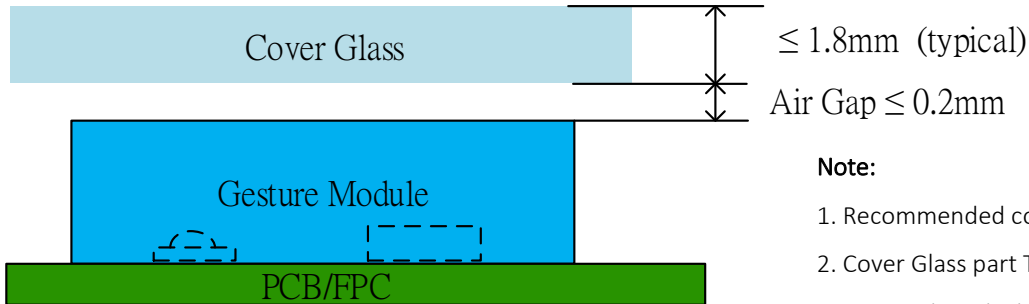

Figure 3. PAJ7620F2 Package Outline Diagram

## 2.2 Recommend Mechanical Design

PixArt suggests mechanical design as below to optimize the performance.



**Note:**

1. Recommended cover glass material: Glass or PC
2. Cover Glass part Transparency: > 90%
3. Cover Glass thickness  $\leq 1.8\text{mm}$ , For different thickness of cover glass, Without Object , need to check if ObjectSize = 0 .
4. Cover Glass should close to PAJ7620F2, Air Gap  $\leq 0.2\text{mm}$

Figure 4. PAJ7620F2 Mechanical Design Guide

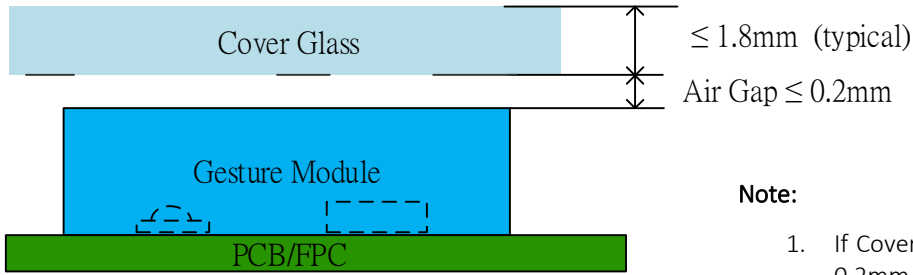

**Note:**

1. If Cover Glass thickness  $\leq 1.8\text{mm}$ , and Air Gap  $\leq 0.2\text{mm}$ , the black Ink region is not necessary.
2. For appearance reason, Ink on cover may be necessary. Please follow the IR Ink spectrum above.

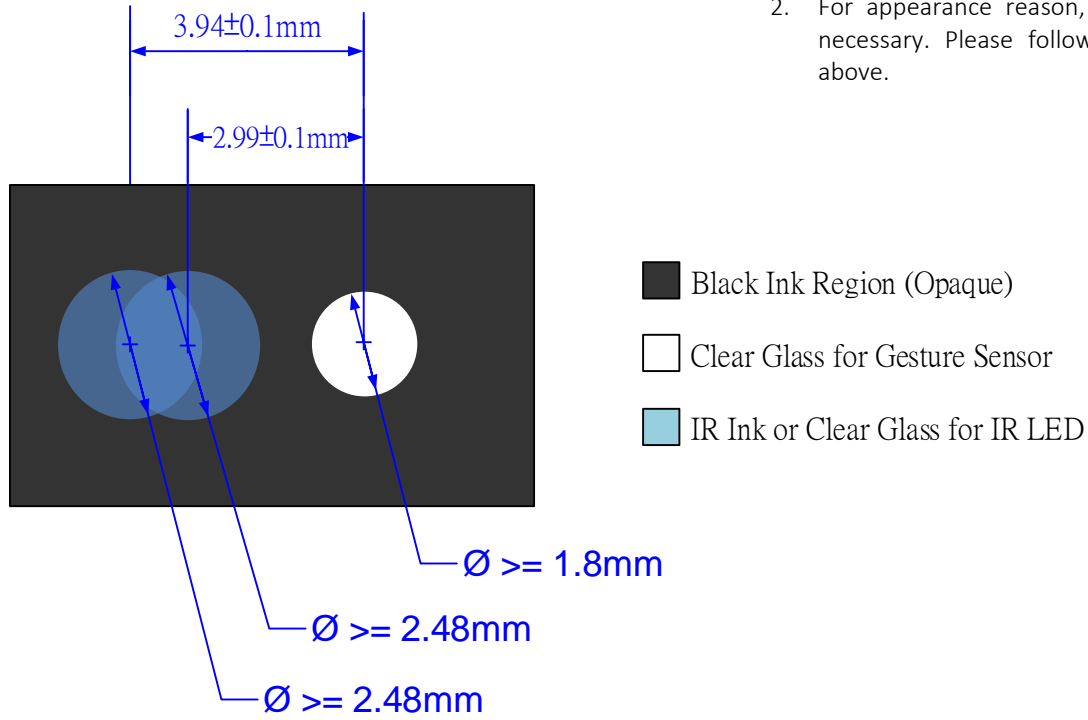

Figure 5. PAJ7620F2 Mechanical Design Guide (IR Ink Suggestion)



### 2.3 Recommended IR Ink Spectrum

IR Ink Vendor: Teikoku Ink

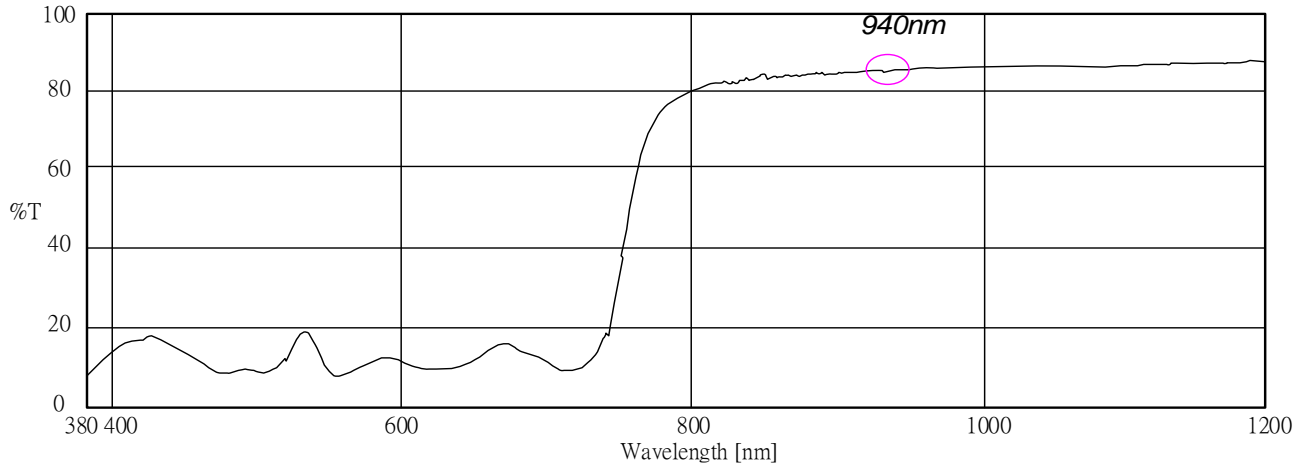

Figure 6. IR Ink Spectrum

### 3.0 Reference Schematics

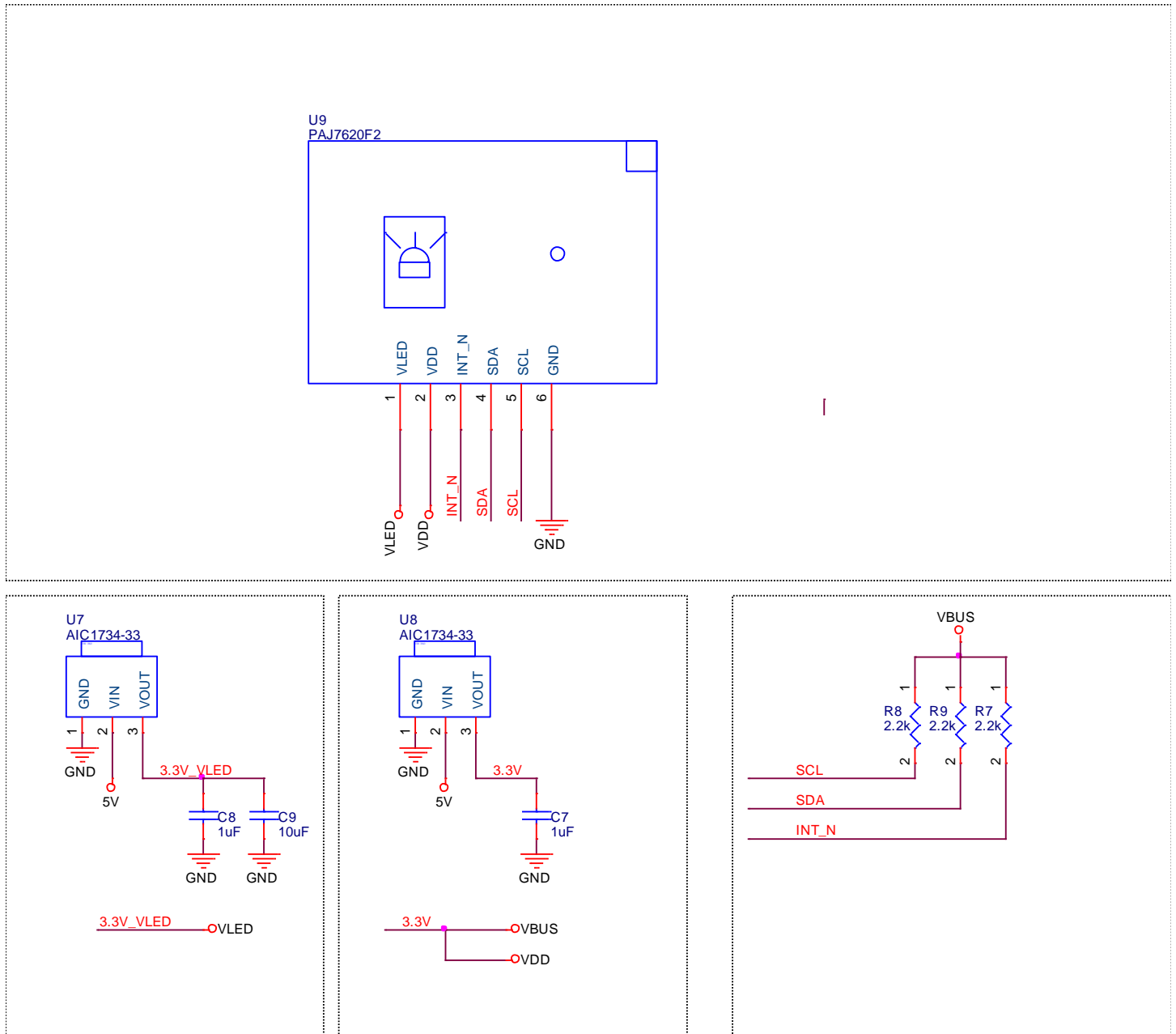

Figure 7. PAJ7620F2 Application Circuit

## 4.0 Sensor Specifications

### 4.1 Absolute Maximum Ratings, $T_A = 27^\circ\text{C}$

Parameters	Symbol	Min.	Max.	Unit	Conditions
Supply Voltage	$V_{DD}$	-	4	V	
LED Supply Voltage	$V_{LED}$	-	4.6	V	
LED Pulse Current	$I_{LED}$	-	2	A	<i>Pulse Width &lt; 500us, Duty Cycle &lt; 5%</i>
I <sup>2</sup> C Pin, INT_N Pin Voltage	$V_{BUS}$	-0.3	$V_{DD}+0.3$	V	SCL, SDA, INT_N
I <sup>2</sup> C Pin, INT_N Pin Current	$I_{BUS}$	-	10	mA	SCL, SDA, INT_N
I/O Pin Voltage	$V_{DDIO}$	-0.3	$V_{DD}+0.3$	V	SPIM_CLK, SPI_SCK, SPI_DATA, SPI_nCS
I/O Pin Current	$I_{DDIO}$	-	10	mA	SPIM_CLK, SPI_SCK, SPI_DATA, SPI_nCS
ESD, human body model	$ESD_{HBM}$	-	2	kV	
ESD, Machine model	$ESD_{MM}$	-	200	V	

Notes:

1. Maximum Ratings are those values beyond which damage to the device may occur.
2. Exposure to these conditions or conditions beyond those indicated may adversely affect device reliability.
3. Functional operation under absolute maximum-rated conditions is not implied. Functional operation should be restricted to the Recommended Operating Conditions.

### 4.2 Recommended Operating Condition

Parameters	Symbol	Min.	Typ.	Max.	Unit	Conditions
Supply Voltage	$V_{DD}$	2.8	-	3.6	V	
LED Supply Voltage	$V_{LED}$	3	-	4.2	V	
Peak LED Driver 1/ 2 Current Pulse	$I_{LED}$	-	360	430	mA	<i>Pulse Width &lt; 500us, Duty Cycle &lt; 5%</i>
I <sup>2</sup> C Pin, INT_N Pin Voltage	$V_{DD}$	2.8	-	3.6	V	SCL, SDA, INT_N
I <sup>2</sup> C Pin, INT_N Pin Current	$I_{BUS}$	-	-	5	mA	SCL, SDA, INT_N
Operating Temperature	$T_{op}$	-20	-	70	°C	
Storage Temperature	$T_{storage}$	-40	-	80	°C	

4.3 Electrical Specifications,  $V_{DD}=2.8V$ ,  $T_A = 27^{\circ}C$

Parameters	Symbol	Min.	Typ.	Max.	Unit	Conditions	
Supply Voltage	$V_{DD}$	2.8	-	3.6	V		
LED Supply Voltage	$V_{LED}$	3.0	-	4.2	V	LED Supply Voltage	
Current Consumption for Operation Modes	PAJ7620F2	$I_{DD}$	-	4.6	-	mA	Under Normal Mode, Near Mode Including LED current @ Peak = 760mA
			-	9.2	-	mA	Under Normal Mode, Far Mode. Including LED current @ Peak = 760mA
			-	7.8	-	mA	Under Gaming Mode, Near Mode Including LED current @ Peak = 760mA
			-	15.3	-	mA	Under Gaming Mode, Far Mode. Including LED current @ Peak = 760mA
	Average Mode	$I_{DD\_Avg\_Mode}$	-	1	-	mA	Excluding IR LED. 120Hz report rate. 2x2 pixel average mode
	Skip Mode	$I_{DD\_Skip\_Mode}$	-	0.8	-	mA	Excluding IR LED. 120Hz report rate. 2x skip mode
Suspend Current	$I_{DD\_SUS}$	-	15	-	$\mu A$		
Current Consumption for Standby State 1	$I_{DD\_ST1}$	-	2.3	-	mA	Refer to Operating Principle 1. Under Normal Mode	
Current Consumption for Standby State 2	$I_{DD\_ST2}$	-	1.5	-	mA	2. $S_1$ , Response Factor =0.5 3. $S_2$ , Response Factor =0.25 4. Including LED current @ Peak = 760mA	
Current Consumption for Proximity Detection	$I_{PS}$		0.2		mA	1. Detecting Rate = 10Hz 2. LED peak current = 600mA 3. LED on time = 6.8 $\mu s$	
I <sup>2</sup> C Bus Input High Voltage	$V_{IH\_I2C}$	$0.7 * V_{BUS}$	-	$V_{BUS} + 0.3$	V		
I <sup>2</sup> C Bus Input Low Voltage	$V_{IL\_I2C}$	-0.3	-	$0.3 * V_{BUS}$	V		
Output Low Voltage	$V_{OL\_SDA}$ $V_{OL\_INT\_N}$	-	-	$0.1 * V_{BUS}$	V	For INT_N, SDA	

4.4 Gesture Functional Specifications

Parameters	Symbol	Min.	Typ.	Max.	Unit	Condition
Gesture Detecting Range	$d_{OP}$	5		30	cm	Calculated from PAJ7620F2 sensor center Near Mode: 5 - 15 cm Far Mode : 15 - 30 cm
Gesture Detecting View Angle	$\theta_{OP}$	30	-	60	degree	Calculated diagonally 60 degree for Near Mode 30 degree for Far Mode
Gesture Speed Response	$\omega$	60		600	degree/s	Angular velocity under Normal Mode
		60		1200		Angular velocity under Gaming Mode
Gesture Update Rate	$f_{Update}$	-	120	240	Hz	120 Hz for Normal Mode 240 Hz for Gaming Mode
LED View Angle	$2\theta_{1/2}$		60		degree	
LED Peak Wavelength	$\lambda$		940		nm	

4.5 Interface AC Specifications

Parameters	Symbol	Min.	Typ.	Max.	Unit	Conditions
I <sup>2</sup> C Speed	$S_{I2C}$	-	100	400	Kbit/s	

## 5.0 Register Tables

### 5.1 Register Bank Select

Bank	Address	Register Name	Default Value	R/W
0/1	0xEF	R_RegBankSel[0]	0x00	R/W
1	0x7F	R_RegBankSel[0]	0x00	R/W

### 5.2 Image Size Setting

Bank	Address	Register Name	Default Value	R/W
0	0xAA	R_ImageHeight[5:0]	0x1E	R/W
0	0xAB	R_ImageWidth[5:0]	0x1E	R/W
1	0x00	Cmd_HSize[5:0]	0x1E	R/W
1	0x01	Cmd_VSize[5:0]	0x1E	R/W
1	0x02	Cmd_HStart[5:0]	0x00	R/W
1	0x03	Cmd_VStart[5:0]	0x00	R/W
1	0x04	Cmd_ASkip_V[5]	0x01	R/W
1	0x04	Cmd_ASkip_H[4]	0x01	R/W
1	0x04	Cmd_DAvg_V[3]	0x00	R/W
1	0x04	Cmd_VFlip[1]	0x00	R/W
1	0x04	Cmd_HFlip[0]	0x00	R/W

### 5.3 AE/AG Controls

Bank	Address	Register Name	Default Value	R/W
0	0x46	R_AELedOff_UB[7:0]	0x60	R/W
0	0x47	R_AELedOff_LB[7:0]	0x20	R/W
0	0x48	R_AE_Exposure_UB[7:0]	0x20	R/W
0	0x49	R_AE_Exposure_UB[15:8]	0x03	R/W
0	0x4A	R_AE_Exposure_LB[7:0]	0xC8	R/W
0	0x4B	R_AE_Exposure_LB[15:8]	0x00	R/W
0	0x4C	R_AE_Gain_UB[7:0]	0x14	R/W
0	0x4D	R_AE_Gain_LB[7:0]	0x00	R/W
0	0x4E	R_AE_Gain_Step[3:0]	0x0A	R/W
0	0x4E	R_SleepAEAG_AutoDisable[4]	0x01	R/W
0	0x4F	R_AE_Gain_Default[6:0]	0x14	R/W
0	0x50	R_Exp_Sel[2:0]	0x00	R/W
0	0x51	R_Manual_GG[0]	0x01	R/W
0	0x51	R_Manual_Exposure[1]	0x00	R/W
0	0x51	R_Manual_Exposure_Default[2]	0x01	R/W
0	0x51	R_AE_EnH[4]	0x00	R/W
0	0x54	AG_stage_GG[7:0]	-	R
0	0x55	Reg_ExposureNum[7:0]	-	R

Bank	Address	Register Name	Default Value	R/W
0	0x56	Reg_ExposureNum[15:8]	-	R
0	0x57	Reg_ggh[1:0]	-	R
0	0x57	Reg_global[3:0]	-	R
0	0x58	AE_LED_Off_YAvg[8:1]	-	R
0	0x59	AE_Dec[0]	-	R
0	0x59	AE_Inc[1]	-	R
0	0x5A	AE_Normal_Factor[2:0]	-	R
1	0x42	R_global[3:0]	0x08	R/W
1	0x44	R_ggh[1:0]	0x00	R/W

#### 5.4 Interrupt Controls

Bank	Address	Register Name	Default Value	R/W
0	0x40	R_MCU_IntFlagGClr	0x01	R/W
0	0x40	R_MCU_IntFlagInv	0x00	R/W
0	0x41	R_Int_1_En[7:0]	0xFF	R/W
0	0x42	R_Int_2_En[7:0]	0xFF	R/W
0	0x43	IntFlag_1[7:0]	-	R
0	0x44	IntFlag_2[7:0]	-	R

#### 5.5 Gesture Mode Controls

Bank	Address	Register Name	Default Value	R/W
0	0x83	R_LightThd[7:0]	0x20	R/W
0	0x84	R_GestureStartTh[7:0]	0x20	R/W
0	0x85	R_GestureStartTh[9:8]	0x00	R/W
0	0x86	R_GestureEndTh[7:0]	0x10	R/W
0	0x87	R_GestureEndTh[9:8]	0x00	R/W
0	0x88	R_ObjectMinZ[4:0]	0x05	R/W
0	0x89	R_ObjectMaxZ[5:0]	0x18	R/W
0	0x8C	R_ProcessResolution[1:0]	0x03	R/W
0	0x8D	R_TimeDelayNum[7:0]	0x00	R/W
0	0x8E	R_Disable45Degree	0x00	R/W
0	0x8E	R_45DegreeRatio[3:0]	0xF0	R/W
0	0x8F	R_XtoYGain	0x01	R/W
0	0x8F	R_XYGainRatio[3:0]	0x08	R/W
0	0x90	R_NoMotionCountThd[6:0]	0x0C	R/W
0	0x91	R_NoObjectCountThd[6:0]	0x06	R/W
0	0x92	R_NormalizedImageWidth[4:0]	0x1E	R/W
0	0x93	R_XDirectionThd[4:0]	0x0D	R/W
0	0x94	R_YDirectionThd[4:0]	0x0A	R/W

Bank	Address	Register Name	Default Value	R/W
0	0x95	R_ZDirectionThd[4:0]	0x0C	R/W
0	0x96	R_ZDirectionXYThd[4:0]	0x0A	R/W
0	0x97	R_ZDirectionAngleThd[3:0]	0x04	R/W
0	0x98	R_RotateAngleThd[5:0]	0x0A	R/W
0	0x99	R_RotateContiEnh	0x01	R/W
0	0x99	R_RotateContiThd[5:0]	0x00	R/W
0	0x9A	R_RotateXYThd[4:0]	0x0A	R/W
0	0x9B	R_RotateZThd[4:0]	0x0A	R/W
0	0x9C	R_FilterWeight[1:0]	0x03	R/W
0	0x9C	R_FilterDistThd[4:0]	0x0A	R/W
0	0x9D	R_StartDistThd[3:0]	0x03	R/W
0	0x9D	R_EndDistThd[2:0]	0x03	R/W
0	0x9F	R_RotateEnh	0x01	R/W
0	0x9F	R_ZDirectionEnh	0x01	R/W
0	0x9F	R_YDirectionEnh	0x01	R/W
0	0x9F	R_XDirectionEnh	0x01	R/W
0	0xA5	R_FilterImage	0x01	R/W
0	0xA5	R_FilterAverage_Mode	0x00	R/W
0	0xA5	R_UseLightWeight	0x01	R/W
0	0xA9	R_DiffAngleThd[3:0]	0x04	R/W
0	0xAC	ObjectCenterX[7:0]	-	R
0	0xAD	ObjectCenterX[12:8]	-	R
0	0xAE	ObjectCenterY[7:0]	-	R
0	0xAF	ObjectCenterY[12:8]	-	R
0	0xB0	ObjectAvgY[8:1]	-	R
0	0xB1	ObjectSize[7:0]	-	R
0	0xB2	ObjectSize[11:8]	-	R
0	0xB3	Gx[5:0]	-	R
0	0xB4	Gy[5:0]	-	R
0	0xB5	Gz[6:0]	-	R
0	0xB6	GestureResult[3:0]	-	R
0	0xB6	State[1:0]	-	R
0	0xB7	WaveCount[3:0]	-	R
0	0xB7	AbortCount[2:0]	-	R
0	0xB8	NoObjectCount[7:0]	-	R
0	0xB9	NoMotionCount[7:0]	-	R
0	0xBA	LightCount[5:0]	-	R
0	0xBB	LightAcc[7:0]	-	R



Bank	Address	Register Name	Default Value	R/W
0	0xBC	LightAcc[9:8]	-	R
0	0xBD	TimeAcc[7:0]	-	R
0	0xBE	TimeAcc[12:8]	-	R
0	0xBF	GxAcc[7:0]	-	R
0	0xC0	GxAcc[9:8]	-	R
0	0xC1	GyAcc[7:0]	-	R
0	0xC2	GyAcc[9:8]	-	R
0	0xC3	VelX[7:0]	-	R
0	0xC4	VelX[11:8]	-	R
0	0xC5	VelY[7:0]	-	R
0	0xC6	VelY[11:8]	-	R
0	0xC7	AngleAcc[7:0]	-	R
0	0xC8	AngleAcc[10:8]	-	R
0	0xC9	CurAngle[4:0]	-	R
0	0xCA	XGainValue[7:0]	-	R
0	0xCB	YGainValue[7:0]	-	R
0	0xCC	R_YtoZSum[5:0]	0x1A	R/W
0	0xCD	R_YtoZFactor[5:0]	0x0D	R/W
0	0xCE	R_PositionFilterLength[2:0]	0x03	R/W
0	0xCE	R_ProcessFilterLength[2:0]	0x00	R/W
0	0xCF	R_WaveCountThd[3:0]	0x03	R/W
0	0xCF	R_WaveAngleThd[3:0]	0x06	R/W
0	0xD0	R_AbortCountThd[2:0]	0x22	R/W
0	0xD0	R_AbortXYRatio[4:0]		R/W
0	0xD1	R_AbortLength[6:0]	0x0F	R/W
0	0xD2	R_AbortIntervalCountThd[5:0]	0x88	R/W
0	0xD2	R_ConfirmMode		R/W
0	0xD2	R_WaveEnh		R/W
0	0xD3	PositionFilterCenterX[7:0]	-	R
0	0xD4	PositionFilterCenterX[11:8]	-	R
0	0xD4	PositionFilterCenterY[11:8]	-	R
0	0xD5	PositionFilterCenterY[7:0]	-	R
0	0xD6	PositionFilterAvgY[7:0]	-	R
0	0xD7	PositionFilterAvgY[8]	-	R
0	0xD7	PositionFilterSize[9:8]	-	R
0	0xD8	PositionFilterSize[7:0]	-	R
0	0xD9	ProcessFilterSize[9:8]	-	R
0	0xD9	ProcessFilterAvgY[8]	-	R
0	0xD9	AbortIntervalCount[9:8]	-	R
0	0xDA	ProcessFilterCenterX[7:0]	-	R
0	0xDB	ProcessFilterCenterX[11:8]	-	R
0	0xDB	ProcessFilterCenterY[11:8]	-	R
0	0xDC	ProcessFilterCenterY[7:0]	-	R

Bank	Address	Register Name	Default Value	R/W
0	0xDD	ProcessFilterSize[7:0]	-	R
0	0xDE	ProcessFilterAvgY[7:0]	-	R
0	0xDF	AbortIntervalCount[7:0]	-	R

## 5.6 Cursor Mode Controls

Bank	Address	Register Name	Default Value	R/W
0	0x32	R_CursorUseTop	0x01	R/W
0	0x32	R_CursorUseBGModel	0x00	R/W
0	0x32	R_CursorInvertY	0x00	R/W
0	0x32	R_CursorInvertX	0x01	R/W
0	0x32	R_CursorTopRatio[1:0]	0x02	R/W
0	0x33	R_PositionFilterStartSizeTh[7:0]	0x01	R/W
0	0x34	R_PositionFilterStartSizeTh[8]	0x00	R/W
0	0x35	R_ProcessFilterStartSizeTh[7:0]	0x01	R/W
0	0x36	R_ProcessFilterStartSizeTh[8]	0x00	R/W
0	0x37	R_CursorClampLeft[4:0]	0x09	R/W
0	0x38	R_CursorClampRight[4:0]	0x15	R/W
0	0x39	R_CursorClampUp[4:0]	0x0A	R/W
0	0x3A	R_CursorClampDown[4:0]	0x12	R/W
0	0x3B	CursorClampCenterX[7:0]	0x00	R
0	0x3C	CursorClampCenterX[11:8]	0x7D	R
0	0x3D	CursorClampCenterY[7:0]	0x0F	R
0	0x3E	CursorClampCenterY[11:8]	0xA0	R
0	0x8B	R_Cursor_ObjectSizeTh[7:0]	0x10	R/W
0	0x8C	R_PositionResolution[2:0]	0x07	R/W

## 5.7 Proximity Mode Controls

Bank	Address	Register Name	Default Value	R/W
0	0x69	R_Pox_UB[7:0]	0xC8	R/W
0	0x6A	R_Pox_LB[7:0]	0x40	R/W
0	0x6B	S_State	-	R
0	0x6C	S_AvgY[8:1]	-	R

## 5.8 EFuse Program Controls

Bank	Address	Register Name	Default Value	R/W
0	0x70	R_EFuse_A[5:0]	0x00	R/W
0	0x70	R_EFuse_READ	0x00	R/W
0	0x70	R_EFuse_ENB	0x01	R/W
0	0x71	R_EFuse_SEL[2:0]	0x00	R/W
0	0x71	R_PROGRAM_BitsCnt[3:0]	0x00	R/W
0	0x72	R_EFuse_PROGRAM_En	0x00	R/W
0	0x72	EFuse_PROGRAM	0x00	R
0	0x73	R_EFuse_PROGRAM_CLKCnt[14:8]	0x00	R/W
0	0x74	R_EFuse_PROGRAM_CLKCnt[7:0]	0xF0	R/W
0	0x75	R_EFuse_PROGRAM_Data[7:0]	0x00	R/W
0	0x76	EFuse_Dout[63:56]	-	R
0	0x77	EFuse_Dout[55:48]	-	R
0	0x78	EFuse_Dout[47:40]	-	R
0	0x79	EFuse_Dout[39:32]	-	R
0	0x7A	EFuse_Dout[31:24]	-	R
0	0x7B	EFuse_Dout[23:16]	-	R
0	0x7C	EFuse_Dout[15:8]	-	R
0	0x7D	EFuse_Dout[7:0]	-	R

## 5.9 Background Controls

Bank	Address	Register Name	Default Value	R/W
0	0x9F	R_UseBGModel	0x01	R/W
0	0x9F	R_BGUseDiffWeight	0x00	R/W
0	0x9F	R_BGUpdateAtProcess	0x00	R/W
0	0x9F	R_BGUpdateMaxIntensity_En	0x01	R/W
0	0xA0	R_BGUpdateMaxIntensity[7:0]	0x03	R/W
0	0xA1	R_BGFilterLengthUp[1:0]	0x01	R/W
0	0xA1	R_BGFilterLengthDown[1:0]	0x10	R/W
0	0xA2	R_BGDiffThd[5:0]	0x08	R/W
0	0xA3	R_BGUpdateFreq[7:0]	0x00	R/W
0	0xA4	R_BGUpdateFreq[9:8]	0x03	R/W
0	0xA4	R_BGResolution[1:0]	0x03	R/W

**5.10 Lens Shading Compensation**

Bank	Address	Register Name	Default Value	R/W
1	0x04	R_LS_Comp_DAVg_V	0x00	R/W
1	0x25	R_LensShadingComp_EnH	0x00	R/W
1	0x26	R_OffsetX[6:0]	0x00	R/W
1	0x27	R_OffsetY[6:0]	0x00	R/W
1	0x28	R_LSC[6:0]	0x40	R/W
1	0x29	R_LSFT[3:0]	0x0A	R/W

**5.11 LED Controls**

Bank	Address	Register Name	Default Value	R/W
1	0x30	R_LED_SoftStart_time[7:0]	0x03	R/W
1	0x31	R_LED2_DAC_EnL	0x00	R/W
1	0x31	R_LED1_DAC_EnL	0x00	R/W
1	0x31	R_LED2_DAC_manual	0x00	R/W
1	0x31	R_LED1_DAC_manual	0x00	R/W
1	0x32	R_LED1_DAC_UB[4:0]	0x14	R/W
1	0x33	R_LED2_DAC_UB[4:0]	0x14	R/W
1	0x34	R_LEDC_Step_Up[4:0]	0x07	R/W
1	0x35	R_LEDC_Step_Down[4:0]	0x07	R/W

**5.12 Sleep Mode**

Bank	Address	Register Name	Default Value	R/W
0	0x45	SleepMode_Status[1:0]	-	R
0	0x52	R_SleepAE1[1:0]	0x00	R/W
0	0x52	R_SleepAE2[1:0]	0x00	R/W
0	0x52	R_SleepAG1[1:0]	0x00	R/W
0	0x52	R_SleepAG2[1:0]	0x00	R/W
1	0x65	R_IDLE_TIME[7:0]	0xB4	R/W
1	0x66	R_IDLE_TIME[15:8]		
1	0x67	R_IDLE_TIME_SLEEP_1[7:0]	0x168	R/W
1	0x68	R_IDLE_TIME_SLEEP_1[15:8]		
1	0x69	R_IDLE_TIME_SLEEP_2[7:0]	0x2D0	R/W
1	0x6A	R_IDLE_TIME_SLEEP_2[15:8]		
1	0x6B	R_Obj_TIME_1[7:0]	0x4B0	R/W
1	0x6C	R_Obj_TIME_1[15:8]		
1	0x6D	R_Obj_TIME_2[7:0]	0x960	R/W
1	0x6E	R_Obj_TIME_2[15:8]		
1	0x6F	R_TG_INIT_TIME[7:0]	0x32	R/W
1	0x71	R_TG_POWERON_WAKEUP_TIME	0x00	R/W

Bank	Address	Register Name	Default Value	R/W
1	0x72	R_TG_EnH	0x00	R/W
1	0x73	R_AUTO_SLEEP_Mode1	0x00	R/W
1	0x73	R_AUTO_SLEEP_Mode2	0x00	R/W
1	0x73	R_AUTO_WakeUP_Mode	0x00	R/W
1	0x74	R_WakeUpSig_Sel[1:0]	0x00	R/W

### 5.13 Clock Controls

Bank	Address	Register Name	Default Value	R/W
0	0x3F	R_oscrpcd	0x00	R/W
0	0x5C	R_SenClkPrd[5:0]	0x02	R/W
0	0x5D	R_SENCLK_Control	0x00	R/W
0	0x5E	R_Other_CLK_manual	0x00	R/W
0	0x5F	R_CLK_manual	0x7F	R/W
0	0x60	TS_osc_code[6:0]	-	R
0	0x61	R_osc_code[6:0]	0x34	R/W
0	0x63	R_Ref_CLK_Cnt_UB[15:8]	0x03	R/W
0	0x64	R_Ref_CLK_Cnt_UB[7:0]	0xF7	R/W
0	0x65	R_Ref_CLK_Cnt_LB[15:8]	0x03	R/W
0	0x66	R_Ref_CLK_Cnt_LB[7:0]	0xD9	R/W
0	0x67	R_OSC_Wait[7:0]	0x03	R/W
0	0x68	T_osc_range[1:0]	0x01	R/W

### 5.14 Chip/Version ID

Bank	Address	Register Name	Default Value	R/W
0	0x00	PartID[7:0]	0x20	R
0	0x01	PartID[15:8]	0x76	R
0	0x02	VersionID[7:0]	0x01	R

### 5.15 Suspend/Reset

Bank	Address	Register Name	Default Value	R/W
0	0x03	SW_Suspend_EnL	0x01	W
0	0xEE	R_RegBank Reset	0x01	W
0	0xEE	R_TGRegBank_SWRstn	0x01	R/W
0	0xEE	R_DMSRegBank_SWRstn	0x01	R/W

## 5.16 Test Mode

Bank	Address	Register Name	Default Value	R/W
0	0xE0	R_DSP_TestObj_Size[3:0]	0x01	R/W
0	0xE0	R_DSP_Test_Mode[3:0]	0x00	R/W
0	0xE1	R_DSP_TestObj_Hi[7:0]	0x04	R/W
0	0xE2	R_DSP_TestObj_Lo[7:0]	0x41	R/W
0	0xE3	R_DSP_TestObj_Dist[3:0]	0x06	R/W
0	0xE3	R_DSP_TestObj_Speed[3:0]	0x0D	R/W
0	0xE4	R_DSP_TestObj_PosL[5:0]	0x00	R/W
0	0xE5	R_DSP_TestObj_PosR[5:0]	0x8C	R/W
0	0xE6	R_DSP_TestObj_PosU[5:0]	0x4A	R/W
0	0xE7	R_DSP_TestObj_PosD[5:0]	0x00	R/W
0	0xE8	R_DSP_TestObj_FrameCnt[5:0]	0x00	R/W
0	0xE8	R_DSP_TestObj_Num[1:0]	0x00	R/W
0	0xE9	R_DSP_Test_Noise_EnH	0x00	R/W

## 5.17 Reserved Registers List

Bank	Address	Register Name	Default Value	R/W
0	0x5B	Trigger	0x00	R/W
0	0x6D	R_SRAM_DS[3:0]	0x04	R/W
0	0x6E	R_BIST_mode[3:0]	0x00	R/W
0	0x6F	R_BIST_mode_1[3:0]	0x00	R/W
0	0x8A	R_LockReg	0x00	R/W
0	0x8A	R_AutoLock	0x10	R/W
1	0x05	Cmd_DebugMode	0x00	R/W
1	0x06	Cmd_CDS_Timing_Control	0x4B0	R/W
1	0x07	Cmd_CDS_Timing_Control		R/W
1	0x08	Cmd_CDS_Timing_Control	0x0D	R/W
1	0x09	Cmd_CDS_Timing_Control	0x0E	R/W
1	0x0A	Cmd_CDS_Timing_Control	0x708	R/W
1	0x0B	Cmd_CDS_Timing_Control		R/W
1	0x0C	Cmd_CDS_Timing_Control	0x05	R/W
1	0x0D	Cmd_CDS_Timing_Control	0x0F	R/W
1	0x0E	Cmd_CDS_Timing_Control	0x02	R/W
1	0x0F	Cmd_CDS_Timing_Control	0x12	R/W
1	0x10	Cmd_CDS_Timing_Control	0x02	R/W
1	0x11	Cmd_CDS_Timing_Control	0x02	R/W
1	0x12	Cmd_CDS_Timing_Control	0x00	R/W
1	0x13	Cmd_CDS_Timing_Control	0x01	R/W
1	0x14	Cmd_CDS_Timing_Control	0x05	R/W
1	0x15	Cmd_CDS_Timing_Control	0x07	R/W

Bank	Address	Register Name	Default Value	R/W
1	0x16	Cmd_CDS_Timing_Control	0x05	R/W
1	0x17	Cmd_CDS_Timing_Control	0x07	R/W
1	0x18	Cmd_CDS_Timing_Control	0x01	R/W
1	0x19	Cmd_CDS_Timing_Control	0x04	R/W
1	0x1A	Cmd_CDS_Timing_Control	0x05	R/W
1	0x1B	Cmd_CDS_Timing_Control	0x0C	R/W
1	0x1C	Cmd_CDS_Timing_Control	0x2A	R/W
1	0x1D	Cmd_CDS_Timing_Control	0x01	R/W
1	0x1E	R_TG_Mode	0x00	R/W
1	0x21	R_OnOffNegComp[7:0]	0x00	R/W
1	0x22	R_OnOffNegComp[8]	0x00	R/W
1	0x23	R_RowDummyTrailing0_EnH	0x00	R/W
1	0x36	R_I2C_AutoResync_EnH	0x01	R/W
1	0x37	R_I2C_AutoResync_Time[7:0]	0xFF	R/W
1	0x38	R_adc_control	0x03	R/W
1	0x39	R_pwrsv_control	0x01	R/W
1	0x3A	R_I2CID_Sel[2:0]	0x00	R/W
1	0x3E	Cmd_DebugPattern[7:0]	0x00	R/W
1	0x3F	Cmd_DebugPattern[8]	0x00	R/W
1	0x40	R_cds_mode	0x00	R/W
1	0x41	R_dac_control	0x00	R/W
1	0x43	R_pga_test	0x00	R/W
1	0x45	R_adc_test	0x00	R/W
1	0x46	R_ScanDAC_Control	0x00	R/W
1	0x47	R_dac_control	0x00	R/W
1	0x48	R_PDN_Test	0x01	R/W
1	0x4A	R_CP_WOI_HSize[5:0]	0x1E	R/W
1	0x4B	R_CP_WOI_VSize[5:0]	0x1E	R/W
1	0x4C	R_CP_WOI_HStart[5:0]	0x00	R/W
1	0x4D	R_CP_WOI_VStart[5:0]	0x00	R/W
1	0x4E	R_Clamp_control	0xA0	R/W
1	0x4F	R_WAKE_ivreg_EnL[7:0]	0x80	R/W
1	0x50	R_bgp_control	0x00	R/W
1	0x51	R_TS_Test	0x00	R/W
1	0x52	R_ref_gen_EnL_Manual	0x00	R/W
1	0x53	R_ref_gen_EnL	0x00	R/W
1	0x54	R_ref_gen_forceNoPwrsv_EnH	0x00	R/W
1	0x57	R_WAKE_tg_EnL[7:0]	0x80	R/W
1	0x59	T_ab_blk_EnH	0x01	R/W
1	0x5A	T_cds_asout_EnH	0x00	R/W
1	0x5B	T_pixbias[2:0]	0x04	R/W

Bank	Address	Register Name	Default Value	R/W
1	0x5C	T_pxoset_EnH	0x01	R/W
1	0x5D	T_tg_allow_EnH	0x00	R/W
1	0x5E	T_clamp_drv_ctl[1:0]	0x01	R/W
1	0x5F	T_vdda28_lvl[2:0]	0x04	R/W
1	0x60	T_vrtb_shift[1:0]	0x01	R/W
1	0x61	T_flush_lvl[2:0]	0x04	R/W
1	0x63	T_adc_vcmtest_EnH	0x00	R/W
1	0x64	T_GPIO_OPDRV[1:0]	0x00	R/W
1	0x74	R_Control_Mode[2:0]	0x00	R/W
1	0x74	R_GPIO_Probe_En	0x00	R/W
1	0x75	T_ckt_test0	0x00	R/W
1	0x76	T_I2C_OPDRV[1:0]	0x01	R/W
1	0x77	R_SRAM_Read_EnH	0x00	R/W
1	0x7C	R_SPIOOUT_PXDNUM[7:0]	0x384	R/W
1	0x7D	R_SPIOOUT_PXDNUM[15:8]		R/W
1	0x7E	R_SPIOOUT_CSN_Mode[1:0]	0x00	R/W
1	0x7E	R_SPIOOUT_EnH	0x00	R/W



Document Revision History

Revision No.	Date	Description of Change(s)
1.0	29 Mar 2016	1 <sup>st</sup> Released version (Based on DS v1.2)