



DC COMPONENTS CO., LTD.

RECTIFIER SPECIALISTS

UF4001
THRU
UF4007

TECHNICAL SPECIFICATIONS OF ULTRA FAST RECTIFIER
VOLTAGE RANGE - 50 to 1000 Volts CURRENT - 4.0 Amperes

FEATURES

- * Low power loss, high efficiency
- * Low forward voltage drop
- * High current capability
- * Ultra fast switching
- * High surge capability
- * High reliability

MECHANICAL DATA

- * Case: Molded plastic
- * Epoxy: UL 94V-0 rate flame retardant
- * Lead: MIL-STD-202E, Method 208 guaranteed
- * Polarity: Color band denotes cathode end
- * Mounting position: Any
- * Weight: 2.08 grams

MAXIMUM RATINGS AND ELECTRICAL CHARACTERISTICS

Ratings at 25°C ambient temperature unless otherwise specified.
 Single phase, half wave, 60Hz, resistive or inductive load.
 For capacitive load, derate current by 20%.



DO-41

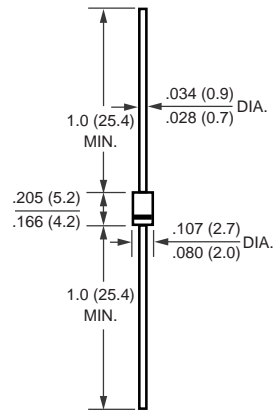

Dimensions in inches and (millimeters)

	SYMBOL	UF4001	UF4002	UF4003	UF4004	UF4005	UF4006	UF4007	UNITS
Maximum Recurrent Peak Reverse Voltage	V _{RRM}	50	100	200	400	600	800	1000	Volts
Maximum RMS Voltage	V _{RMS}	35	70	140	280	420	560	700	Volts
Maximum DC Blocking Voltage	V _{DC}	50	100	200	400	600	800	1000	Volts
Maximum Average Forward Rectified Current at TA = 50°C	I _O	1.0							Amps
Peak Forward Surge Current 8.3 ms single half sine-wave superimposed on rated load (JEDEC Method)	I _{FSM}	30							Amps
Maximum Instantaneous Forward Voltage at 6.0A DC	V _F	1.0			1.7				Volts
Maximum DC Reverse Current at Rated DC Blocking Voltage TA = 25°C	I _R	5.0							uAmps
Maximum Full Load Reverse Current Average, Full Cycle .375" (9.5mm) lead length at TL = 55°C		100							uAmps
Maximum Reverse Recovery Time (Note 1)	t _{rr}	50				75			nSec
Typical Junction Capacitance (Note 2)	C _J	15			12				pF
Operating and Storage Temperature Range	T _J , T _{STG}	-65 to + 150							°C

NOTES : 1. Test Conditions: I_F = 0.5A, I_R = 1.0A, I_{RR} = 0.25A
 2. Measured at 1 MHz and applied reverse voltage of 4.0 volts

RATING AND CHARACTERISTIC CURVES (UF4001 THRU UF4007)

FIG. 1 - TEST CIRCUIT DIAGRAM AND REVERSE RECOVERY TIME CHARACTERISTIC

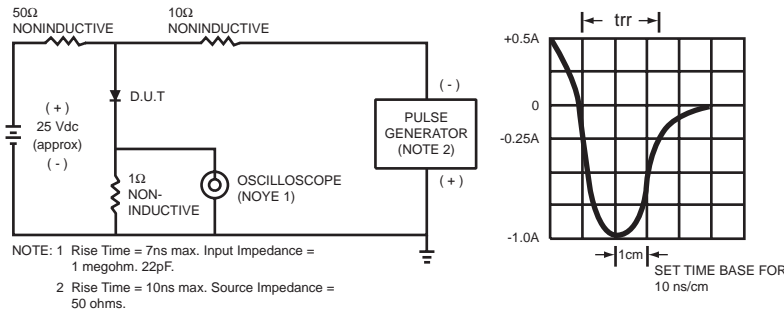

FIG. 2 - TYPICAL FORWARD CURRENT DERATING CURVE

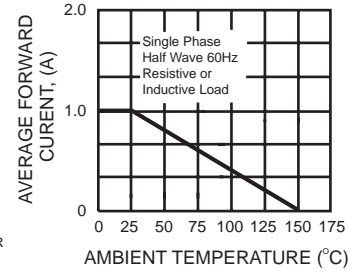

FIG. 3 - TYPICAL REVERSE CHARACTERISTICS

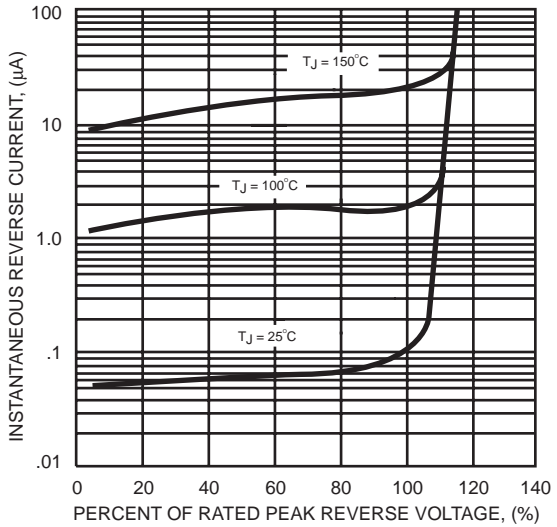

FIG. 4 - TYPICAL INSTANTANEOUS FORWARD CHARACTERISTICS

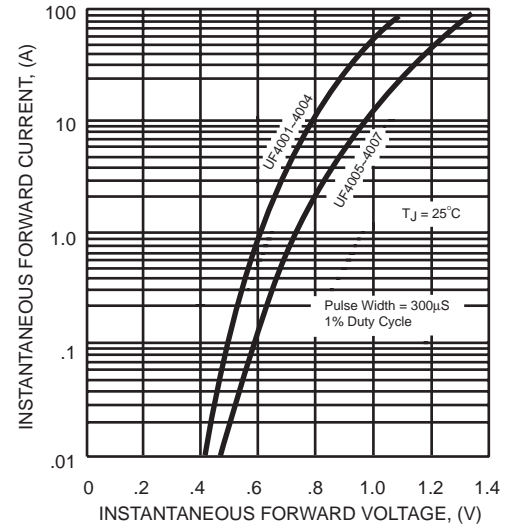

FIG. 5 - MAXIMUM NON-REPETITIVE FORWARD SURGE CURRENT

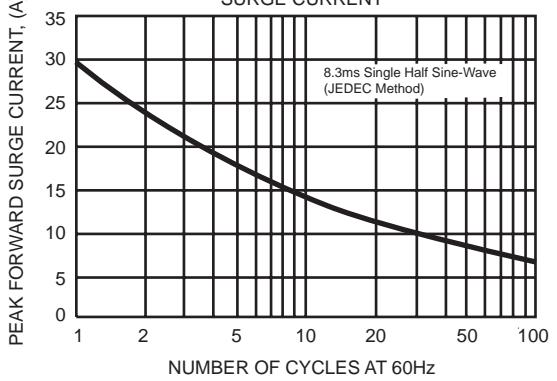
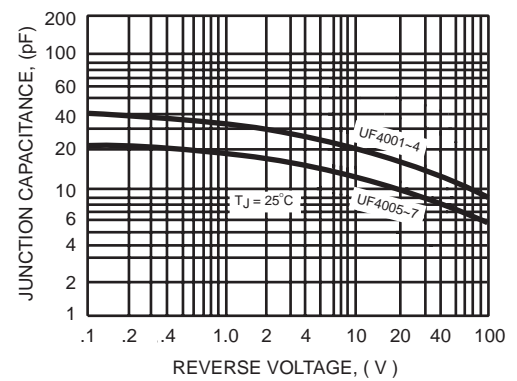

FIG. 6 - TYPICAL JUNCTION CAPACITANCE



DC COMPONENTS CO., LTD.