

## SNx4HC02 Quadruple 2-Input Positive-NOR Gates

### 1 Features

- Wide Operating Voltage Range of 2 V to 6 V
- Outputs Can Drive Up to 10 LSTTL Loads
- Low Power Consumption: Maximum  $I_{CC}$  of 20  $\mu$ A
- Typical  $t_{pd} = 8$  ns
- $\pm 4$ -mA Output Drive at 5 V
- Low Input Current of 1- $\mu$ A Maximum

### 2 Applications

- Education
- Toys
- Musical Instruments
- Medical Healthcare and Fitness
- Grid Infrastructure
- Electronic Point of Sale
- Test and Measurement
- Factory Automation and Control
- Building Automation
- RS Latch
- Falling Edge Detector

### 3 Description

The SNx4HC02 devices contain four independent 2-input NOR gates. They perform the Boolean function  $Y = A + B$  or  $Y = A \cdot \bar{B}$  in positive logic.

#### Device Information<sup>(1)</sup>

PART NUMBER	PACKAGE	BODY SIZE (NOM)
SN74HC02D	SOIC (14)	4.90 mm x 3.91 mm
SN74HC02N	PDIP (14)	19.30 mm x 6.35 mm
SN74HC02PW	TSSOP (14)	5.00 mm x 4.40 mm
SN74HC02NS	SO (14)	10.30 mm x 5.30 mm
SN74HC02DB	SSOP (14)	6.20 mm x 5.30 mm
SN54HC02J	CDIP (14)	19.94 mm x 7.62 mm
SN54HC02W	CFP (14)	9.21 mm x 7.11 mm
SN54HC02FK	LCCC (20)	8.89 mm x 8.89 mm

(1) For all available packages, see the orderable addendum at the end of the data sheet.

### SNx4HC02 Functional Block Diagram

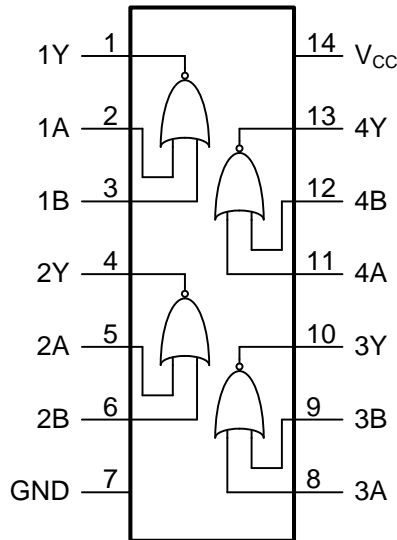

Copyright © 2016, Texas Instruments Incorporated



An IMPORTANT NOTICE at the end of this data sheet addresses availability, warranty, changes, use in safety-critical applications, intellectual property matters and other important disclaimers. PRODUCTION DATA.

On products compliant to MIL-PRF-38535, all parameters are tested unless otherwise noted. On all other products, production processing does not necessarily include testing of all parameters.

## Table of Contents

<b>1 Features</b> ..... 1 <b>2 Applications</b> ..... 1 <b>3 Description</b> ..... 1 <b>4 Revision History</b> ..... 2 <b>5 Pin Configuration and Functions</b> ..... 3 <b>6 Specifications</b> ..... 4 6.1 Absolute Maximum Ratings ..... 4 6.2 ESD Ratings – SN74HC02 ..... 4 6.3 Recommended Operating Conditions ..... 4 6.4 Thermal Information – SN74HC02..... 5 6.5 Thermal Information – SN54HC02..... 5 6.6 Electrical Characteristics ..... 5 6.7 Switching Characteristics ..... 6 6.8 Operating Characteristics..... 6 6.9 Typical Characteristics ..... 6 <b>7 Parameter Measurement Information</b> ..... 7 <b>8 Detailed Description</b> ..... 8 8.1 Overview ..... 8	8.2 Functional Block Diagram ..... 8 8.3 Feature Description..... 8 8.4 Device Functional Modes..... 8 <b>9 Application and Implementation</b> ..... 10 9.1 Application Information..... 10 9.2 Typical Application ..... 10 <b>10 Power Supply Recommendations</b> ..... 11 <b>11 Layout</b> ..... 11 11.1 Layout Guidelines ..... 11 11.2 Layout Example ..... 11 <b>12 Device and Documentation Support</b> ..... 12 12.1 Documentation Support ..... 12 12.2 Related Links ..... 12 12.3 Community Resources..... 12 12.4 Trademarks ..... 12 12.5 Electrostatic Discharge Caution..... 12 12.6 Glossary ..... 12 <b>13 Mechanical, Packaging, and Orderable Information</b> ..... 12
---	--

## 4 Revision History

NOTE: Page numbers for previous revisions may differ from page numbers in the current version.

### Changes from Revision E (August 2003) to Revision F

Page

- |   |        |
|---|--------|
| <ul style="list-style-type: none"> <li>• Added <i>ESD Ratings</i> table, <i>Feature Description</i> section, <i>Device Functional Modes</i>, <i>Application and Implementation</i> section, <i>Power Supply Recommendations</i> section, <i>Layout</i> section, <i>Device and Documentation Support</i> section, and <i>Mechanical, Packaging, and Orderable Information</i> section. .... 1</li> <li>• Removed ordering information. .... 1</li> </ul> | 1<br>1 |
|---|--------|

## 5 Pin Configuration and Functions

D, DB, N, NS, PW, J, or W Package  
14-Pin SOIC, SSOP, PDIP, SO, TSSOP, CDIP, or CFP  
Top View

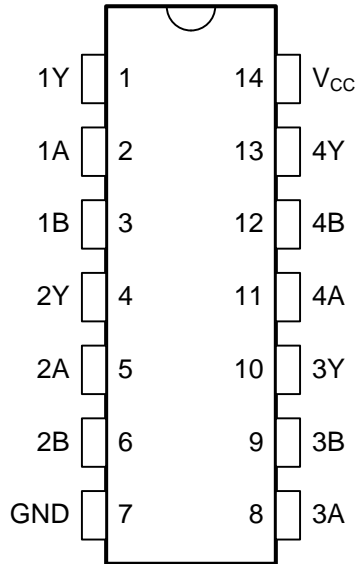

FK Package  
20-Pin LCCC  
Top View

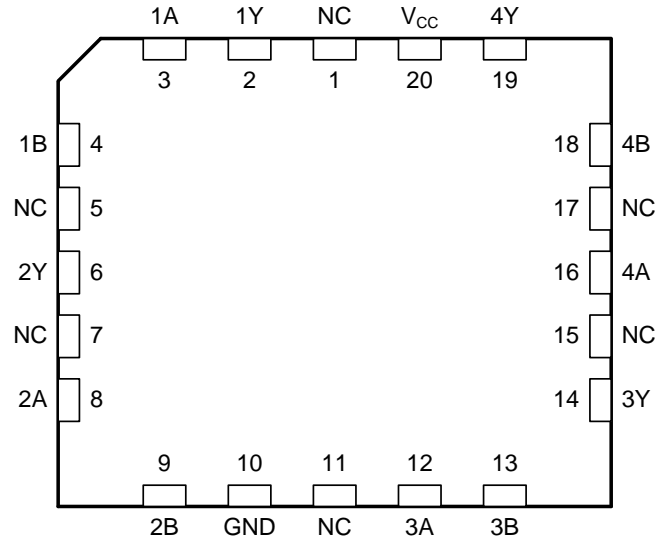

### Pin Functions

NAME	PIN		I/O	DESCRIPTION
	SOIC, SSOP, PDIP, SO, TSSOP, CDIP, CFP	LCCC		
1Y	1	2	O	Gate 1 output
1A	2	3	I	Gate 1 input A
1B	3	4	I	Gate 1 input B
2Y	4	6	O	Gate 2 output
2A	5	8	I	Gate 2 input A
2B	6	9	I	Gate 2 input B
GND	7	10	—	Ground Pin
3A	8	12	I	Gate 3 input A
3B	9	13	I	Gate 3 input B
3Y	10	14	O	Gate 3 output
4A	11	16	I	Gate 4 input A
4B	12	18	I	Gate 4 input B
4Y	13	19	O	Gate 4 output
V <sub>CC</sub>	14	20	—	Power pin
NC	—	1, 5, 7, 11, 15, 17	—	No internal connection

## 6 Specifications

### 6.1 Absolute Maximum Ratings

 over operating free-air temperature range (unless otherwise noted)<sup>(1)</sup>

		MIN	MAX	UNIT
V <sub>CC</sub>	Supply voltage	-0.5	7	V
I <sub>IK</sub>	Input clamp current <sup>(2)</sup>	V <sub>I</sub> < 0 or V <sub>I</sub> > V <sub>CC</sub>		±20 mA
I <sub>OK</sub>	Output clamp current <sup>(2)</sup>	V <sub>O</sub> < 0 or V <sub>O</sub> > V <sub>CC</sub>		±20 mA
I <sub>O</sub>	Continuous output current	V <sub>O</sub> = 0 to V <sub>CC</sub>		±25 mA
	Continuous current through V <sub>CC</sub> or GND			±50 mA
T <sub>j</sub>	Operating virtual junction temperature			150 °C
T <sub>stg</sub>	Storage temperature	-65	150	°C

- (1) Stresses beyond those listed under *Absolute Maximum Ratings* may cause permanent damage to the device. These are stress ratings only, and functional operation of the device at these or any other conditions beyond those indicated under *Recommended Operating Conditions* is not implied. Exposure to absolute-maximum-rated conditions for extended periods may affect device reliability.
- (2) The input and output voltage ratings may be exceeded if the input and output current ratings are observed.

### 6.2 ESD Ratings – SN74HC02

		VALUE	UNIT
V <sub>(ESD)</sub>	Electrostatic discharge	Human-body model (HBM), per ANSI/ESDA/JEDEC JS-001 <sup>(1)</sup>	±1500
		Charged-device model (CDM), per JEDEC specification JESD22-C101 <sup>(2)</sup>	±2000

- (1) JEDEC document JEP155 states that 500-V HBM allows safe manufacturing with a standard ESD control process.
- (2) JEDEC document JEP157 states that 250-V CDM allows safe manufacturing with a standard ESD control process.

### 6.3 Recommended Operating Conditions

 See <sup>(1)</sup>.

		MIN	NOM	MAX	UNIT
V <sub>CC</sub>	Supply voltage	2	5	6	V
V <sub>IH</sub>	High-level input voltage	V <sub>CC</sub> = 2 V	1.5		V
		V <sub>CC</sub> = 4.5 V	3.15		
		V <sub>CC</sub> = 6 V	4.2		
V <sub>IL</sub>	Low-level input voltage	V <sub>CC</sub> = 2 V		0.5	V
		V <sub>CC</sub> = 4.5 V		1.35	
		V <sub>CC</sub> = 6 V		1.8	
V <sub>I</sub>	Input voltage	0		V <sub>CC</sub>	V
V <sub>O</sub>	Output voltage	0		V <sub>CC</sub>	V
Δt/Δv	Input transition rise and fall time	V <sub>CC</sub> = 2 V		1000	ns/V
		V <sub>CC</sub> = 4.5 V		500	
		V <sub>CC</sub> = 6 V		400	
T <sub>A</sub>	Operating free-air temperature	SN54HC02	-55	125	°C
		SN74HC02	-40	85	

- (1) All unused inputs of the device must be held at V<sub>CC</sub> or GND to ensure proper device operation. See the TI application report, *Implications of Slow or Floating CMOS Inputs*, [SCBA004](#).

## 6.4 Thermal Information – SN74HC02

THERMAL METRIC <sup>(1)</sup>		SN74HC02					UNIT
		D (SOIC)	DB (SSOP)	N (PDIP)	NS (SO)	PW (TSSOP)	
		14 PINS	14 PINS	14 PINS	14 PINS	14 PINS	
R <sub>θJA</sub>	Junction-to-ambient thermal resistance <sup>(1)</sup>	94	105.4	54.9	88.8	119.6	°C/W
R <sub>θJC(top)</sub>	Junction-to-case (top) thermal resistance	53.2	57.3	42.5	46.5	48.4	°C/W
R <sub>θJB</sub>	Junction-to-board thermal resistance	48.7	52.7	34.7	47.6	61.3	°C/W
ψ <sub>JT</sub>	Junction-to-top characterization parameter	15.6	22.6	27.9	16.8	5.6	°C/W
ψ <sub>JB</sub>	Junction-to-board characterization parameter	48.4	52.2	34.6	47.2	60.7	°C/W

(1) For more information about traditional and new thermal metrics, see the *Semiconductor and IC Package Thermal Metrics* application report, [SPRA953](#).

## 6.5 Thermal Information – SN54HC02

THERMAL METRIC <sup>(1)</sup>		SN54HC02			UNIT
		J (CDIP)	W (CFP)	FK (LCCC)	
		14 PINS	14 PINS	20 PINS	
R <sub>θJC(top)</sub>	Junction-to-case (top) thermal resistance	53.8	89.6	61.1	°C/W
R <sub>θJB</sub>	Junction-to-board thermal resistance	73.1	164.1	59.8	°C/W
R <sub>θJC(bot)</sub>	Junction-to-case (bottom) thermal resistance	26.7	15.5	11.7	°C/W

(1) For more information about traditional and new thermal metrics, see the *Semiconductor and IC Package Thermal Metrics* application report, [SPRA953](#).

## 6.6 Electrical Characteristics

over recommended operating free-air temperature range (unless otherwise noted)

PARAMETER	TEST CONDITIONS		V <sub>CC</sub>	T <sub>A</sub>	MIN	TYP	MAX	UNIT
V <sub>OH</sub>	V <sub>I</sub> = V <sub>IH</sub> or V <sub>IL</sub>	I <sub>OH</sub> = -20 μA	2 V		1.9	1.998		V
			4.5 V		4.4	4.499		
			6 V		5.9	5.999		
	I <sub>OH</sub> = -4 mA	4.5 V	T <sub>A</sub> = 25°C		3.98	4.3		
			SN54HC02		3.7			
			SN74HC02		3.84			
	I <sub>OH</sub> = -5.2 mA	6 V	T <sub>A</sub> = 25°C		5.48	5.8		
SN54HC02				5.2				
SN74HC02				5.34				
V <sub>OL</sub>	V <sub>I</sub> = V <sub>IH</sub> or V <sub>IL</sub>	I <sub>OL</sub> = 20 μA	2 V		0.002	0.1		V
			4.5 V		0.001	0.1		
			6 V		0.001	0.1		
	I <sub>OL</sub> = 4 mA	4.5 V	T <sub>A</sub> = 25°C		0.17	0.26		
			SN54HC02			0.4		
			SN74HC02			0.33		
	I <sub>OL</sub> = 5.2 mA	6 V	T <sub>A</sub> = 25°C		0.15	0.26		
SN54HC02					0.4			
SN74HC02					0.33			
I <sub>I</sub>	V <sub>I</sub> = V <sub>CC</sub> or 0		6 V	T <sub>A</sub> = 25°C	±0.1	±100		nA
				SN54HC02, SN74HC02		±1000		
I <sub>CC</sub>	V <sub>I</sub> = V <sub>CC</sub> or 0, I <sub>O</sub> = 0		6 V	T <sub>A</sub> = 25°C		2		μA
				SN54HC02		40		
				SN74HC02		20		
C <sub>i</sub>			2 V to 6 V		3	10		pF

## 6.7 Switching Characteristics

 over recommended operating free-air temperature range,  $C_L = 50$  pF (unless otherwise noted) (see Figure 2)

PARAMETER	FROM (INPUT)	TO (OUTPUT)	$V_{CC}$	$T_A$	MIN	TYP	MAX	UNIT
$t_{pd}$	A or B	Y	2 V	$T_A = 25^\circ\text{C}$		45	90	ns
				SN54HC02			135	
				SN74HC02			115	
			4.5 V	$T_A = 25^\circ\text{C}$		9	18	
				SN54HC02			27	
				SN74HC02			23	
			6 V	$T_A = 25^\circ\text{C}$		8	15	
				SN54HC02			23	
				SN74HC02			20	
$t_t$	A or B	Y	2 V	$T_A = 25^\circ\text{C}$		38	75	ns
				SN54HC02			110	
				SN74HC02			95	
			4.5 V	$T_A = 25^\circ\text{C}$		8	15	
				SN54HC02			22	
				SN74HC02			19	
			6 V	$T_A = 25^\circ\text{C}$		6	13	
				SN54HC02			19	
				SN74HC02			16	

## 6.8 Operating Characteristics

 $T_A = 25^\circ\text{C}$ 

PARAMETER	TEST CONDITIONS	TYP	UNIT
$C_{pd}$ Power dissipation capacitance per gate	No load	22	pF

## 6.9 Typical Characteristics

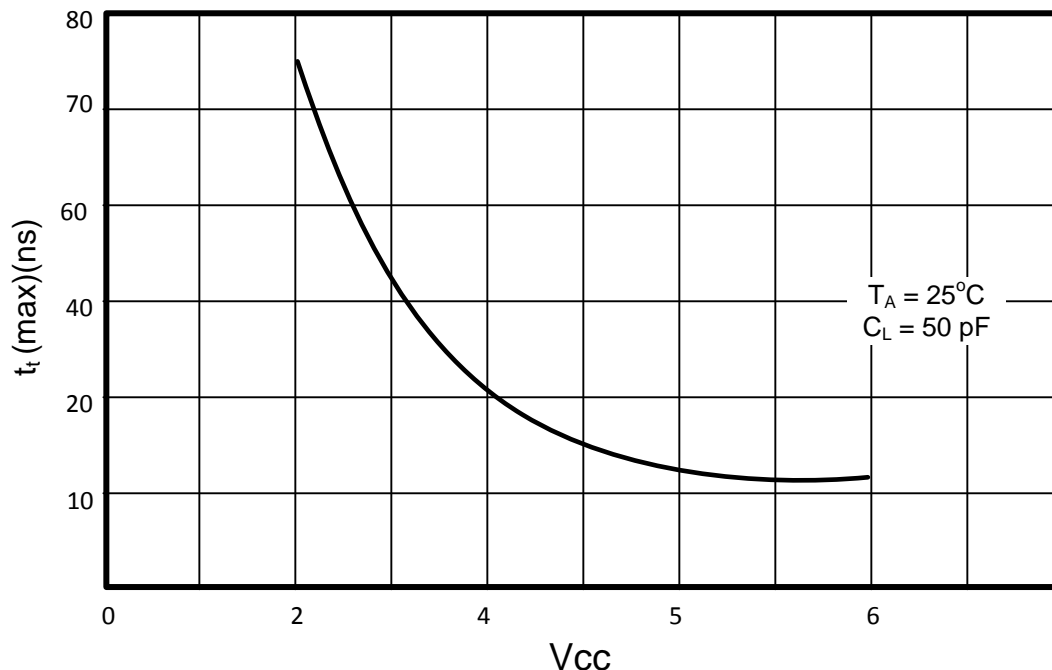
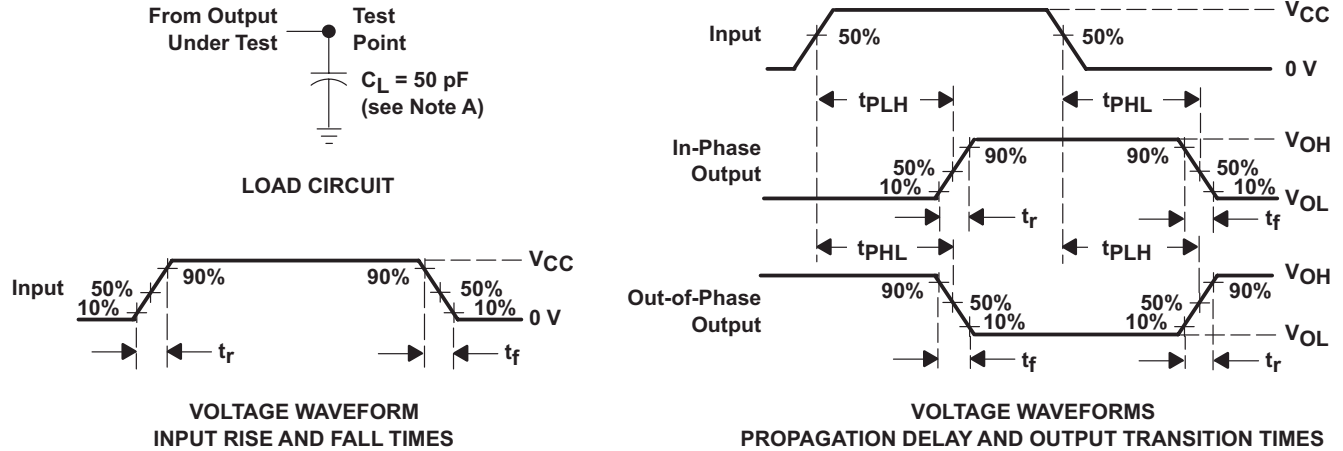

Figure 1.  $t_t$  vs  $V_{CC}$

## 7 Parameter Measurement Information



- $C_L$  includes probe and test-fixture capacitance.
- Phase relationships between waveforms were chosen arbitrarily. All input pulses are supplied by generators having the following characteristics:  $PRR \leq 1 \text{ MHz}$ ,  $Z_O = 50 \Omega$ ,  $t_r = 6 \text{ ns}$ ,  $t_f = 6 \text{ ns}$ .
- The outputs are measured one at a time with one input transition per measurement.
- $t_{PLH}$  and  $t_{PHL}$  are the same as  $t_{pd}$ .

**Figure 2. Load Circuit and Voltage Waveforms**

## 8 Detailed Description

### 8.1 Overview

The SNx4HC02 devices are quad 2-input NOR gates. These devices are members of the High-Speed CMOS (HC) logic family. The HC family of logic is optimized to operate with a 5-V supply, is low noise without characteristic overshoot and undershoot, has low power consumption, small propagation delay, balanced propagation delay and transition times, and operates over a wide temperature range.

### 8.2 Functional Block Diagram

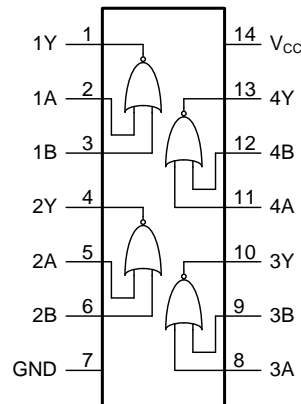

Copyright © 2016, Texas Instruments Incorporated

### 8.3 Feature Description

#### 8.3.1 Operating Voltage Range

The SNx4HC series of devices offer a wide operating voltage range from 2 V to 6 V.

#### 8.3.2 LSTTL Loads

The outputs of the SNx4HC series can drive up to 10 LSTTL loads.

#### 8.3.3 Low Power Consumption

The SNx4HC02 offers low power consumption of 20  $\mu$ A maximum.

#### 8.3.4 Output Drive Capability

At 5 V, the outputs have  $\pm 4$  mA of output drive capability.

#### 8.3.5 Low Input Current Leakage

Inputs have low input current leakage of 1  $\mu$ A maximum.

### 8.4 Device Functional Modes

[Table 1](#) lists the functional modes of the SNx4HC02.

**Table 1. Function Table**

INPUTS		OUTPUT Y
A	B	
H	X	L
X	H	L
L	L	H





Figure 3. Logic Diagram (Positive Logic)

## 9 Application and Implementation

### NOTE

Information in the following applications sections is not part of the TI component specification, and TI does not warrant its accuracy or completeness. TI's customers are responsible for determining suitability of components for their purposes. Customers should validate and test their design implementation to confirm system functionality.

### 9.1 Application Information

The SNX4HC02 is a low-drive CMOS device that can be used for a multitude of NOR type functions. The device can produce 4 mA of drive current at 5 V, making it ideal for driving multiple outputs and good for low-noise applications. This application is for using a single SNX4HC02 as a falling edge detector circuit.

The edge detector operates by using the inherent propagation delay from input to output of each device stage. In steady-state, the inputs to the output stage will always be different, and thus the output will always be low. Only during the brief time when both inputs are low (that is, immediately following a falling edge on  $V_{IN}$ ), the output will be high.

### 9.2 Typical Application

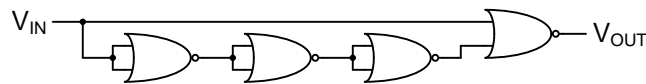

Copyright © 2016, Texas Instruments Incorporated

**Figure 4. Falling Edge Detector Schematic**

#### 9.2.1 Design Requirements

This device uses CMOS technology and has balanced output drive. Take care to avoid bus contention because it can drive currents that would exceed maximum limits. The high drive also creates fast edges into light loads, so routing and load conditions must be considered to prevent ringing.

The output pulse time will be approximately three times  $t_{pd}$  from [Switching Characteristics](#) for the selected  $V_{CC}$ , device, and temperature range.

#### 9.2.2 Detailed Design Procedure

1. Recommended Input Conditions – For rise time and fall time specifications, see  $\Delta t/\Delta V$  in [Recommended Operating Conditions](#).
  - For specified high and low levels, see  $V_{IH}$  and  $V_{IL}$  in [Recommended Operating Conditions](#).
  - Inputs are not overvoltage tolerant, allowing them to go as high as  $V_{CC}$ .
2. Recommend Output Conditions
  - Load currents must not exceed 20 mA per output and 50 mA total for the part.
  - Outputs must not be pulled above  $V_{CC}$ .

## Typical Application (continued)

### 9.2.3 Application Curve

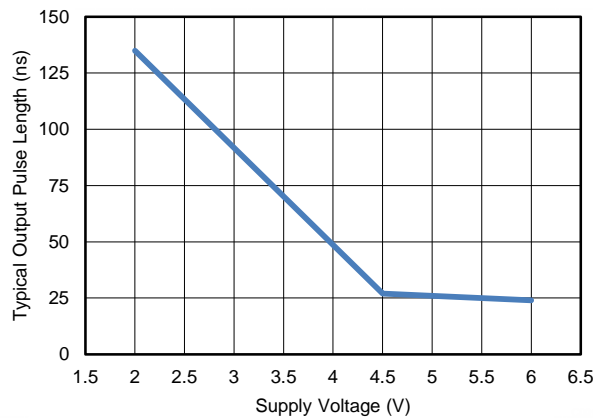

Figure 5. Typical Output Pulse Length Over  $V_{CC}$  Range

## 10 Power Supply Recommendations

The power supply can be any voltage between the minimum and maximum supply voltage rating located in [Recommended Operating Conditions](#). Each  $V_{CC}$  pin must have a good bypass capacitor to prevent power disturbance. For devices with a single supply, TI recommends a 0.1- $\mu\text{F}$  bypass capacitor. If there are multiple  $V_{CC}$  pins, TI recommends a 0.01- $\mu\text{F}$  or 0.022- $\mu\text{F}$  bypass capacitors for each power pin. It is acceptable to parallel multiple bypass capacitors to reject different frequencies of noise. Two bypass capacitors of value 0.1  $\mu\text{F}$  and 1  $\mu\text{F}$  are commonly used in parallel. For best results, install the bypass capacitor(s) as close to the power pin as possible.

## 11 Layout

### 11.1 Layout Guidelines

When using multiple bit logic devices, inputs must not float. In many cases, functions or parts of functions of digital logic devices are unused. Some examples are when only two inputs of a triple-input AND gate are used, or when only 3 of the 4-buffer gates are used. Such input pins must not be left unconnected because the undefined voltages at the outside connections result in undefined operational states. Specified in [Absolute Maximum Ratings](#) are rules that must be observed under all circumstances. All unused inputs of digital logic devices must be connected to a high or low bias to prevent them from floating. The logic level that must be applied to any particular unused input depends on the function of the device. Generally they will be tied to GND or  $V_{CC}$ , whichever makes more sense or is more convenient. It is acceptable to float outputs unless the part is a transceiver. If the transceiver has an output enable pin, it will disable the outputs section of the part when asserted. This will not disable the input section of the I/Os so they also cannot float when disabled.

### 11.2 Layout Example

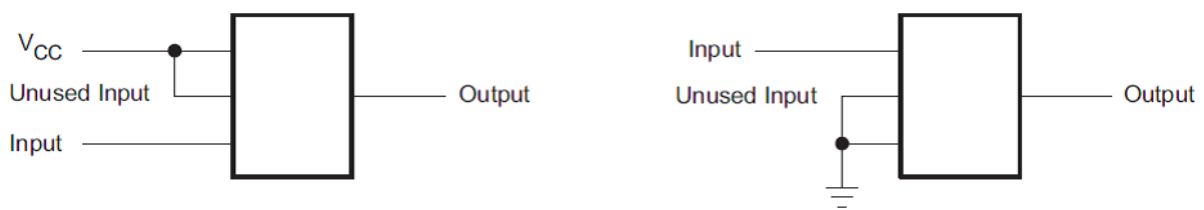

Figure 6. Layout Recommendation

## 12 Device and Documentation Support

### 12.1 Documentation Support

#### 12.1.1 Related Documentation

For related documentation, see the following:

*Implications of Slow or Floating CMOS Inputs*, [SCBA004](#)

### 12.2 Related Links

The table below lists quick access links. Categories include technical documents, support and community resources, tools and software, and quick access to sample or buy.

**Table 2. Related Links**

PARTS	PRODUCT FOLDER	SAMPLE & BUY	TECHNICAL DOCUMENTS	TOOLS & SOFTWARE	SUPPORT & COMMUNITY
SN54HC02	<a href="#">Click here</a>	<a href="#">Click here</a>	<a href="#">Click here</a>	<a href="#">Click here</a>	<a href="#">Click here</a>
SN74HC02	<a href="#">Click here</a>	<a href="#">Click here</a>	<a href="#">Click here</a>	<a href="#">Click here</a>	<a href="#">Click here</a>

### 12.3 Community Resources

The following links connect to TI community resources. Linked contents are provided "AS IS" by the respective contributors. They do not constitute TI specifications and do not necessarily reflect TI's views; see TI's [Terms of Use](#).

**TI E2E™ Online Community** *TI's Engineer-to-Engineer (E2E) Community*. Created to foster collaboration among engineers. At [e2e.ti.com](http://e2e.ti.com), you can ask questions, share knowledge, explore ideas and help solve problems with fellow engineers.

**Design Support** *TI's Design Support* Quickly find helpful E2E forums along with design support tools and contact information for technical support.

### 12.4 Trademarks

E2E is a trademark of Texas Instruments.  
All other trademarks are the property of their respective owners.

### 12.5 Electrostatic Discharge Caution



These devices have limited built-in ESD protection. The leads should be shorted together or the device placed in conductive foam during storage or handling to prevent electrostatic damage to the MOS gates.

### 12.6 Glossary

[SLYZ022](#) — *TI Glossary*.

This glossary lists and explains terms, acronyms, and definitions.

## 13 Mechanical, Packaging, and Orderable Information

The following pages include mechanical, packaging, and orderable information. This information is the most current data available for the designated devices. This data is subject to change without notice and revision of this document. For browser-based versions of this data sheet, refer to the left-hand navigation.

**PACKAGING INFORMATION**

Orderable Device	Status (1)	Package Type	Package Drawing	Pins	Package Qty	Eco Plan (2)	Lead/Ball Finish (6)	MSL Peak Temp (3)	Op Temp (°C)	Device Marking (4/5)	Samples
5962-8404101VCA	ACTIVE	CDIP	J	14	1	TBD	Call TI	N / A for Pkg Type	-55 to 125	5962-8404101VC A SNV54HC02J	<a href="#">Samples</a>
84041012A	ACTIVE	LCCC	FK	20	1	TBD	POST-PLATE	N / A for Pkg Type	-55 to 125	84041012A SNJ54HC 02FK	<a href="#">Samples</a>
8404101CA	ACTIVE	CDIP	J	14	1	TBD	Call TI	N / A for Pkg Type	-55 to 125	8404101CA SNJ54HC02J	<a href="#">Samples</a>
8404101DA	ACTIVE	CFP	W	14	1	TBD	Call TI	N / A for Pkg Type	-55 to 125	8404101DA SNJ54HC02W	<a href="#">Samples</a>
JM38510/65101B2A	ACTIVE	LCCC	FK	20	1	TBD	POST-PLATE	N / A for Pkg Type	-55 to 125	JM38510/ 65101B2A	<a href="#">Samples</a>
JM38510/65101BCA	ACTIVE	CDIP	J	14	1	TBD	Call TI	N / A for Pkg Type	-55 to 125	JM38510/ 65101BCA	<a href="#">Samples</a>
JM38510/65101BDA	ACTIVE	CFP	W	14	1	TBD	Call TI	N / A for Pkg Type	-55 to 125	JM38510/ 65101BDA	<a href="#">Samples</a>
M38510/65101B2A	ACTIVE	LCCC	FK	20	1	TBD	POST-PLATE	N / A for Pkg Type	-55 to 125	JM38510/ 65101B2A	<a href="#">Samples</a>
M38510/65101BCA	ACTIVE	CDIP	J	14	1	TBD	Call TI	N / A for Pkg Type	-55 to 125	JM38510/ 65101BCA	<a href="#">Samples</a>
M38510/65101BDA	ACTIVE	CFP	W	14	1	TBD	Call TI	N / A for Pkg Type	-55 to 125	JM38510/ 65101BDA	<a href="#">Samples</a>
SN54HC02J	ACTIVE	CDIP	J	14	1	TBD	Call TI	N / A for Pkg Type	-55 to 125	SN54HC02J	<a href="#">Samples</a>
SN74HC02D	ACTIVE	SOIC	D	14	50	Green (RoHS & no Sb/Br)	NIPDAU	Level-1-260C-UNLIM	-40 to 85	HC02	<a href="#">Samples</a>
SN74HC02DBR	ACTIVE	SSOP	DB	14	2000	Green (RoHS & no Sb/Br)	NIPDAU	Level-1-260C-UNLIM	-40 to 85	HC02	<a href="#">Samples</a>
SN74HC02DE4	ACTIVE	SOIC	D	14	50	Green (RoHS & no Sb/Br)	NIPDAU	Level-1-260C-UNLIM	-40 to 85	HC02	<a href="#">Samples</a>
SN74HC02DR	ACTIVE	SOIC	D	14	2500	Green (RoHS & no Sb/Br)	NIPDAU   SN	Level-1-260C-UNLIM	-40 to 85	HC02	<a href="#">Samples</a>
SN74HC02DRE4	ACTIVE	SOIC	D	14	2500	Green (RoHS & no Sb/Br)	NIPDAU	Level-1-260C-UNLIM	-40 to 85	HC02	<a href="#">Samples</a>

Orderable Device	Status (1)	Package Type	Package Drawing	Pins	Package Qty	Eco Plan (2)	Lead/Ball Finish (6)	MSL Peak Temp (3)	Op Temp (°C)	Device Marking (4/5)	Samples
SN74HC02DRG4	ACTIVE	SOIC	D	14	2500	Green (RoHS & no Sb/Br)	NIPDAU	Level-1-260C-UNLIM	-40 to 85	HC02	<a href="#">Samples</a>
SN74HC02DT	ACTIVE	SOIC	D	14	250	Green (RoHS & no Sb/Br)	NIPDAU	Level-1-260C-UNLIM	-40 to 85	HC02	<a href="#">Samples</a>
SN74HC02N	ACTIVE	PDIP	N	14	25	Green (RoHS & no Sb/Br)	NIPDAU   SN	N / A for Pkg Type	-40 to 85	SN74HC02N	<a href="#">Samples</a>
SN74HC02NE4	ACTIVE	PDIP	N	14	25	Green (RoHS & no Sb/Br)	NIPDAU	N / A for Pkg Type	-40 to 85	SN74HC02N	<a href="#">Samples</a>
SN74HC02NSR	ACTIVE	SO	NS	14	2000	Green (RoHS & no Sb/Br)	NIPDAU	Level-1-260C-UNLIM	-40 to 85	HC02	<a href="#">Samples</a>
SN74HC02NSRG4	ACTIVE	SO	NS	14	2000	Green (RoHS & no Sb/Br)	NIPDAU	Level-1-260C-UNLIM	-40 to 85	HC02	<a href="#">Samples</a>
SN74HC02PW	ACTIVE	TSSOP	PW	14	90	Green (RoHS & no Sb/Br)	NIPDAU	Level-1-260C-UNLIM	-40 to 85	HC02	<a href="#">Samples</a>
SN74HC02PWG4	ACTIVE	TSSOP	PW	14	90	Green (RoHS & no Sb/Br)	NIPDAU	Level-1-260C-UNLIM	-40 to 85	HC02	<a href="#">Samples</a>
SN74HC02PWR	ACTIVE	TSSOP	PW	14	2000	Green (RoHS & no Sb/Br)	NIPDAU   SN	Level-1-260C-UNLIM	-40 to 85	HC02	<a href="#">Samples</a>
SN74HC02PWRG4	ACTIVE	TSSOP	PW	14	2000	Green (RoHS & no Sb/Br)	NIPDAU	Level-1-260C-UNLIM	-40 to 85	HC02	<a href="#">Samples</a>
SN74HC02PWT	ACTIVE	TSSOP	PW	14	250	Green (RoHS & no Sb/Br)	NIPDAU	Level-1-260C-UNLIM	-40 to 85	HC02	<a href="#">Samples</a>
SNJ54HC02FK	ACTIVE	LCCC	FK	20	1	TBD	POST-PLATE	N / A for Pkg Type	-55 to 125	84041012A SNJ54HC 02FK	<a href="#">Samples</a>
SNJ54HC02J	ACTIVE	CDIP	J	14	1	TBD	Call TI	N / A for Pkg Type	-55 to 125	8404101CA SNJ54HC02J	<a href="#">Samples</a>
SNJ54HC02W	ACTIVE	CFP	W	14	1	TBD	Call TI	N / A for Pkg Type	-55 to 125	8404101DA SNJ54HC02W	<a href="#">Samples</a>

(1) The marketing status values are defined as follows:

**ACTIVE:** Product device recommended for new designs.

**LIFEBUY:** TI has announced that the device will be discontinued, and a lifetime-buy period is in effect.

**NRND:** Not recommended for new designs. Device is in production to support existing customers, but TI does not recommend using this part in a new design.

**PREVIEW:** Device has been announced but is not in production. Samples may or may not be available.

**OBSELETE:** TI has discontinued the production of the device.

(2) **RoHS:** TI defines "RoHS" to mean semiconductor products that are compliant with the current EU RoHS requirements for all 10 RoHS substances, including the requirement that RoHS substance do not exceed 0.1% by weight in homogeneous materials. Where designed to be soldered at high temperatures, "RoHS" products are suitable for use in specified lead-free processes. TI may reference these types of products as "Pb-Free".

**RoHS Exempt:** TI defines "RoHS Exempt" to mean products that contain lead but are compliant with EU RoHS pursuant to a specific EU RoHS exemption.

**Green:** TI defines "Green" to mean the content of Chlorine (Cl) and Bromine (Br) based flame retardants meet JS709B low halogen requirements of  $\leq 1000$ ppm threshold. Antimony trioxide based flame retardants must also meet the  $\leq 1000$ ppm threshold requirement.

(3) **MSL, Peak Temp.** - The Moisture Sensitivity Level rating according to the JEDEC industry standard classifications, and peak solder temperature.

(4) There may be additional marking, which relates to the logo, the lot trace code information, or the environmental category on the device.

(5) Multiple Device Markings will be inside parentheses. Only one Device Marking contained in parentheses and separated by a "~" will appear on a device. If a line is indented then it is a continuation of the previous line and the two combined represent the entire Device Marking for that device.

(6) **Lead/Ball Finish** - Orderable Devices may have multiple material finish options. Finish options are separated by a vertical ruled line. Lead/Ball Finish values may wrap to two lines if the finish value exceeds the maximum column width.

**Important Information and Disclaimer:** The information provided on this page represents TI's knowledge and belief as of the date that it is provided. TI bases its knowledge and belief on information provided by third parties, and makes no representation or warranty as to the accuracy of such information. Efforts are underway to better integrate information from third parties. TI has taken and continues to take reasonable steps to provide representative and accurate information but may not have conducted destructive testing or chemical analysis on incoming materials and chemicals. TI and TI suppliers consider certain information to be proprietary, and thus CAS numbers and other limited information may not be available for release.

In no event shall TI's liability arising out of such information exceed the total purchase price of the TI part(s) at issue in this document sold by TI to Customer on an annual basis.

**OTHER QUALIFIED VERSIONS OF SN54HC02, SN54HC02-SP, SN74HC02 :**

- Catalog: [SN74HC02](#), [SN54HC02](#)
  
- Automotive: [SN74HC02-Q1](#), [SN74HC02-Q1](#)
  
- Enhanced Product: [SN74HC02-EP](#), [SN74HC02-EP](#)
  
- Military: [SN54HC02](#)
  
- Space: [SN54HC02-SP](#)

NOTE: Qualified Version Definitions:

- Catalog - TI's standard catalog product
- Automotive - Q100 devices qualified for high-reliability automotive applications targeting zero defects
- Enhanced Product - Supports Defense, Aerospace and Medical Applications
- Military - QML certified for Military and Defense Applications
- Space - Radiation tolerant, ceramic packaging and qualified for use in Space-based application



**TAPE AND REEL INFORMATION**

**QUADRANT ASSIGNMENTS FOR PIN 1 ORIENTATION IN TAPE**

\*All dimensions are nominal

Device	Package Type	Package Drawing	Pins	SPQ	Reel Diameter (mm)	Reel Width W1 (mm)	A0 (mm)	B0 (mm)	K0 (mm)	P1 (mm)	W (mm)	Pin1 Quadrant
SN74HC02DR	SOIC	D	14	2500	330.0	16.4	6.5	9.0	2.1	8.0	16.0	Q1
SN74HC02DR	SOIC	D	14	2500	330.0	16.8	6.5	9.5	2.1	8.0	16.0	Q1
SN74HC02DR	SOIC	D	14	2500	330.0	16.4	6.5	9.0	2.1	8.0	16.0	Q1
SN74HC02DRG4	SOIC	D	14	2500	330.0	16.4	6.5	9.0	2.1	8.0	16.0	Q1
SN74HC02DRG4	SOIC	D	14	2500	330.0	16.4	6.5	9.0	2.1	8.0	16.0	Q1
SN74HC02DT	SOIC	D	14	250	330.0	16.4	6.5	9.0	2.1	8.0	16.0	Q1
SN74HC02NSR	SO	NS	14	2000	330.0	16.4	8.1	10.4	2.5	12.0	16.0	Q1
SN74HC02PWR	TSSOP	PW	14	2000	330.0	12.4	6.9	5.6	1.6	8.0	12.0	Q1
SN74HC02PWR	TSSOP	PW	14	2000	330.0	12.4	6.9	5.6	1.6	8.0	12.0	Q1
SN74HC02PWRG4	TSSOP	PW	14	2000	330.0	12.4	6.9	5.6	1.6	8.0	12.0	Q1
SN74HC02PWT	TSSOP	PW	14	250	330.0	12.4	6.9	5.6	1.6	8.0	12.0	Q1

**TAPE AND REEL BOX DIMENSIONS**



\*All dimensions are nominal

Device	Package Type	Package Drawing	Pins	SPQ	Length (mm)	Width (mm)	Height (mm)
SN74HC02DR	SOIC	D	14	2500	367.0	367.0	38.0
SN74HC02DR	SOIC	D	14	2500	364.0	364.0	27.0
SN74HC02DR	SOIC	D	14	2500	333.2	345.9	28.6
SN74HC02DRG4	SOIC	D	14	2500	367.0	367.0	38.0
SN74HC02DRG4	SOIC	D	14	2500	333.2	345.9	28.6
SN74HC02DT	SOIC	D	14	250	210.0	185.0	35.0
SN74HC02NSR	SO	NS	14	2000	367.0	367.0	38.0
SN74HC02PWR	TSSOP	PW	14	2000	364.0	364.0	27.0
SN74HC02PWR	TSSOP	PW	14	2000	367.0	367.0	35.0
SN74HC02PWRG4	TSSOP	PW	14	2000	367.0	367.0	35.0
SN74HC02PWT	TSSOP	PW	14	250	367.0	367.0	35.0

FK (S-CQCC-N\*\*)

LEADLESS CERAMIC CHIP CARRIER

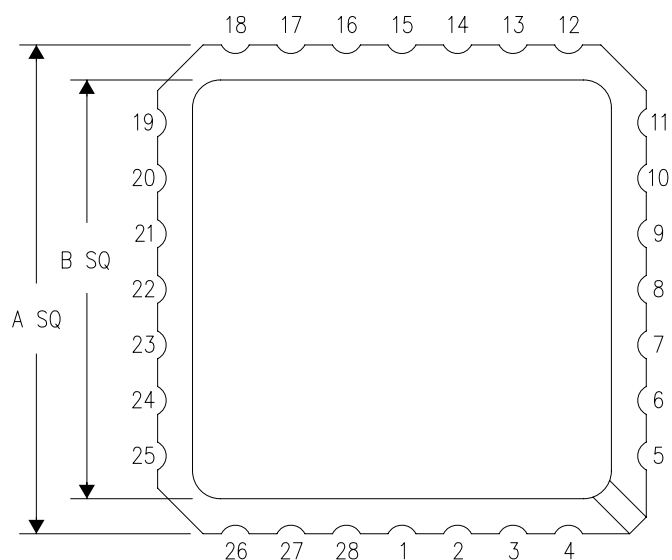
28 TERMINAL SHOWN



NO. OF TERMINALS **	A		B	
	MIN	MAX	MIN	MAX
20	0.342 (8,69)	0.358 (9,09)	0.307 (7,80)	0.358 (9,09)
28	0.442 (11,23)	0.458 (11,63)	0.406 (10,31)	0.458 (11,63)
44	0.640 (16,26)	0.660 (16,76)	0.495 (12,58)	0.560 (14,22)
52	0.740 (18,78)	0.761 (19,32)	0.495 (12,58)	0.560 (14,22)
68	0.938 (23,83)	0.962 (24,43)	0.850 (21,6)	0.858 (21,8)
84	1.141 (28,99)	1.165 (29,59)	1.047 (26,6)	1.063 (27,0)

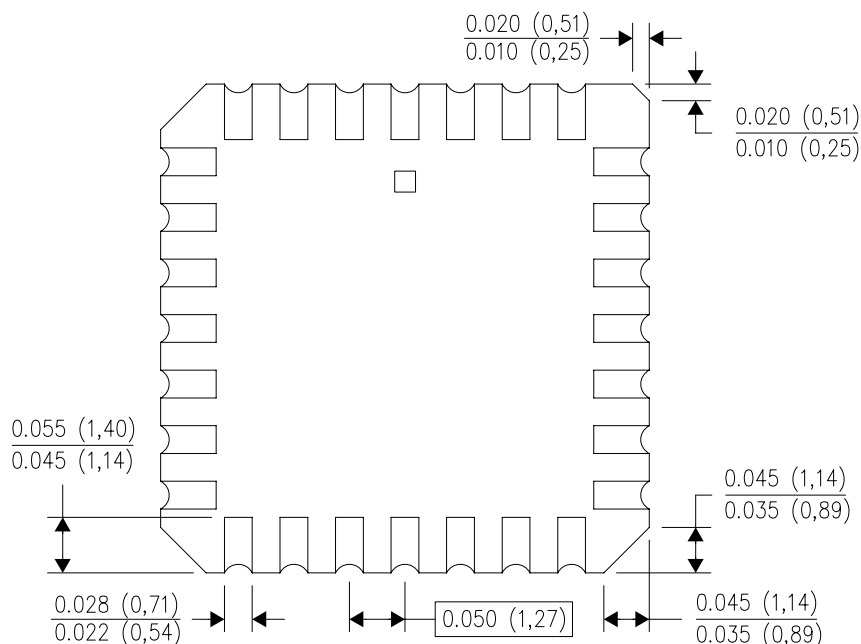

4040140/D 01/11

- NOTES:
- All linear dimensions are in inches (millimeters).
  - This drawing is subject to change without notice.
  - This package can be hermetically sealed with a metal lid.
  - Falls within JEDEC MS-004

## MECHANICAL DATA

**NS (R-PDSO-G\*\*)**

**PLASTIC SMALL-OUTLINE PACKAGE**

**14-PINS SHOWN**



- NOTES:
- A. All linear dimensions are in millimeters.
  - B. This drawing is subject to change without notice.
  - C. Body dimensions do not include mold flash or protrusion, not to exceed 0,15.

W (R-GDFP-F14)

CERAMIC DUAL FLATPACK



- NOTES:
- A. All linear dimensions are in inches (millimeters).
  - B. This drawing is subject to change without notice.
  - C. This package can be hermetically sealed with a ceramic lid using glass frit.
  - D. Index point is provided on cap for terminal identification only.
  - E. Falls within MIL STD 1835 GDFP1-F14

N (R-PDIP-T\*\*)

PLASTIC DUAL-IN-LINE PACKAGE

16 PINS SHOWN



- NOTES:
- A. All linear dimensions are in inches (millimeters).
  - B. This drawing is subject to change without notice.
  - Falls within JEDEC MS-001, except 18 and 20 pin minimum body length (Dim A).
  - The 20 pin end lead shoulder width is a vendor option, either half or full width.

4040049/E 12/2002

DB (R-PDSO-G\*\*)

PLASTIC SMALL-OUTLINE

28 PINS SHOWN



- NOTES: A. All linear dimensions are in millimeters.  
 B. This drawing is subject to change without notice.  
 C. Body dimensions do not include mold flash or protrusion not to exceed 0,15.  
 D. Falls within JEDEC MO-150

J 14

**GENERIC PACKAGE VIEW**  
**CDIP - 5.08 mm max height**  
CERAMIC DUAL IN LINE PACKAGE



Images above are just a representation of the package family, actual package may vary.  
Refer to the product data sheet for package details.

4040083-5/G



J0014A



# PACKAGE OUTLINE

CDIP - 5.08 mm max height

CERAMIC DUAL IN LINE PACKAGE



4214771/A 05/2017

NOTES:

1. All controlling linear dimensions are in inches. Dimensions in brackets are in millimeters. Any dimension in brackets or parenthesis are for reference only. Dimensioning and tolerancing per ASME Y14.5M.
2. This drawing is subject to change without notice.
3. This package is hermetically sealed with a ceramic lid using glass frit.
4. Index point is provided on cap for terminal identification only and on press ceramic glass frit seal only.
5. Falls within MIL-STD-1835 and GDIP1-T14.

# EXAMPLE BOARD LAYOUT

J0014A

CDIP - 5.08 mm max height

CERAMIC DUAL IN LINE PACKAGE

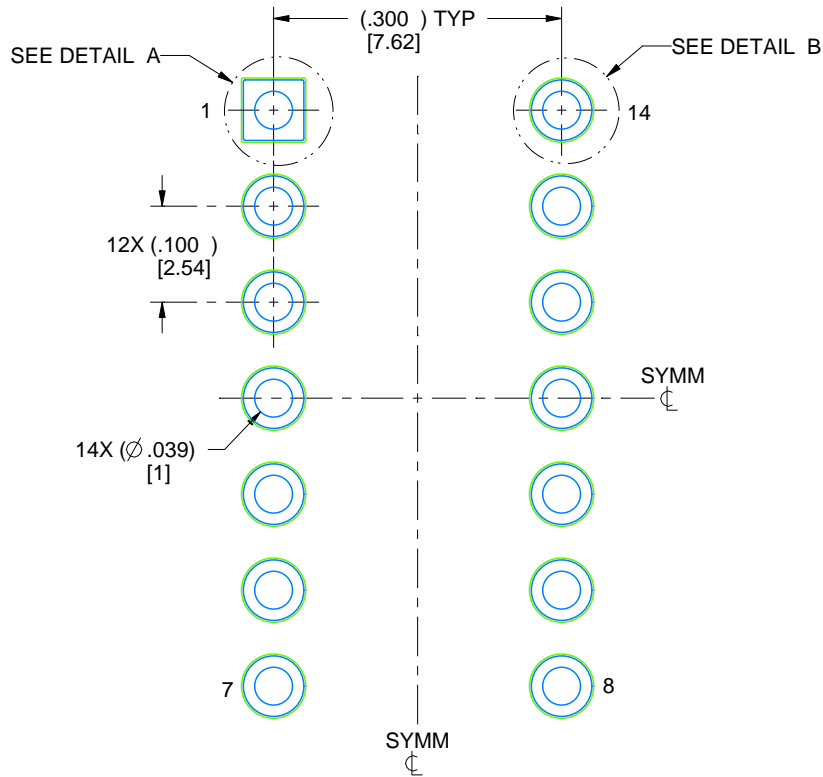

LAND PATTERN EXAMPLE  
NON-SOLDER MASK DEFINED  
SCALE: 5X

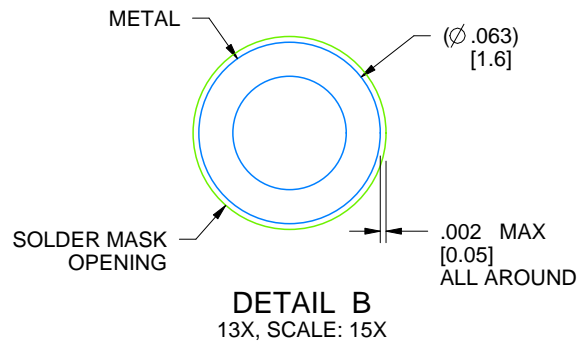
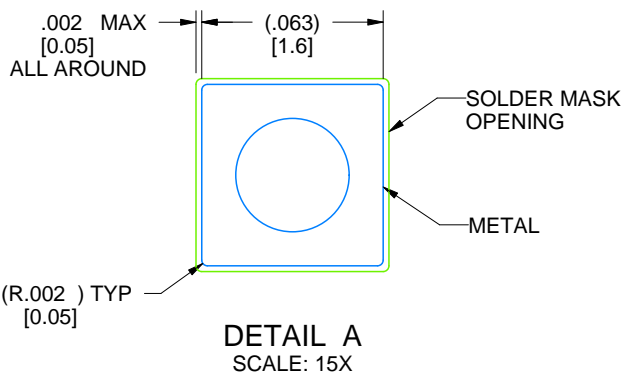

4214771/A 05/2017



D (R-PDSO-G14)

PLASTIC SMALL OUTLINE

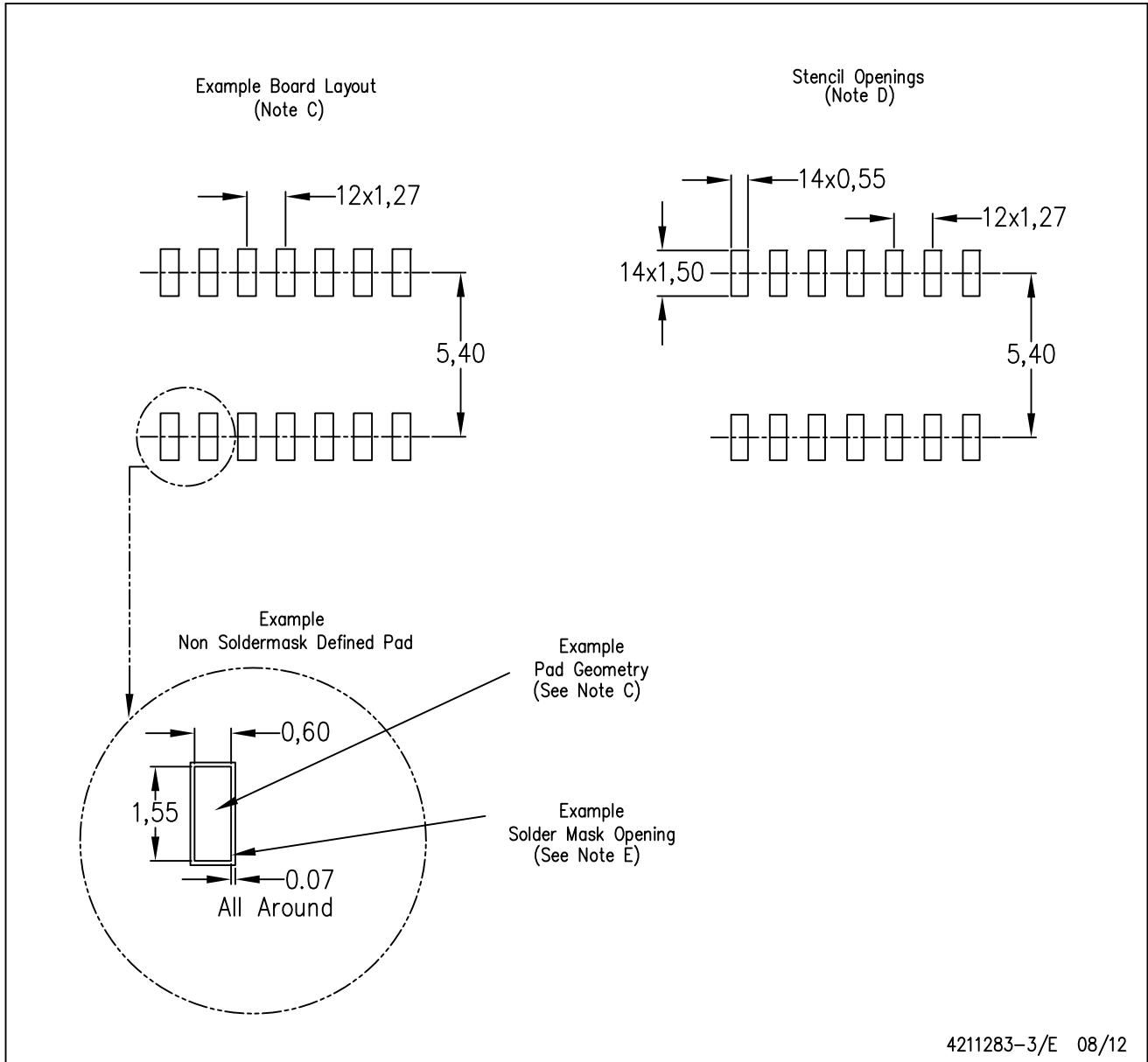



- NOTES:
- All linear dimensions are in millimeters.
  - This drawing is subject to change without notice.
  - Publication IPC-7351 is recommended for alternate designs.
  - Laser cutting apertures with trapezoidal walls and also rounding corners will offer better paste release. Customers should contact their board assembly site for stencil design recommendations. Refer to IPC-7525 for other stencil recommendations.
  - Customers should contact their board fabrication site for solder mask tolerances between and around signal pads.

PW (R-PDSO-G14)

PLASTIC SMALL OUTLINE



4040064-3/G 02/11

- NOTES:
- A. All linear dimensions are in millimeters. Dimensioning and tolerancing per ASME Y14.5M-1994.
  - B. This drawing is subject to change without notice.
  -  C. Body length does not include mold flash, protrusions, or gate burrs. Mold flash, protrusions, or gate burrs shall not exceed 0,15 each side.
  -  D. Body width does not include interlead flash. Interlead flash shall not exceed 0,25 each side.
  - E. Falls within JEDEC MO-153

PW (R-PDSO-G14)

PLASTIC SMALL OUTLINE



4211284-2/G 08/15

- NOTES:
- All linear dimensions are in millimeters.
  - This drawing is subject to change without notice.
  - Publication IPC-7351 is recommended for alternate designs.
  - Laser cutting apertures with trapezoidal walls and also rounding corners will offer better paste release. Customers should contact their board assembly site for stencil design recommendations. Refer to IPC-7525 for other stencil recommendations.
  - Customers should contact their board fabrication site for solder mask tolerances between and around signal pads.

## IMPORTANT NOTICE AND DISCLAIMER

TI PROVIDES TECHNICAL AND RELIABILITY DATA (INCLUDING DATASHEETS), DESIGN RESOURCES (INCLUDING REFERENCE DESIGNS), APPLICATION OR OTHER DESIGN ADVICE, WEB TOOLS, SAFETY INFORMATION, AND OTHER RESOURCES "AS IS" AND WITH ALL FAULTS, AND DISCLAIMS ALL WARRANTIES, EXPRESS AND IMPLIED, INCLUDING WITHOUT LIMITATION ANY IMPLIED WARRANTIES OF MERCHANTABILITY, FITNESS FOR A PARTICULAR PURPOSE OR NON-INFRINGEMENT OF THIRD PARTY INTELLECTUAL PROPERTY RIGHTS.

These resources are intended for skilled developers designing with TI products. You are solely responsible for (1) selecting the appropriate TI products for your application, (2) designing, validating and testing your application, and (3) ensuring your application meets applicable standards, and any other safety, security, or other requirements. These resources are subject to change without notice. TI grants you permission to use these resources only for development of an application that uses the TI products described in the resource. Other reproduction and display of these resources is prohibited. No license is granted to any other TI intellectual property right or to any third party intellectual property right. TI disclaims responsibility for, and you will fully indemnify TI and its representatives against, any claims, damages, costs, losses, and liabilities arising out of your use of these resources.

TI's products are provided subject to TI's Terms of Sale ([www.ti.com/legal/termsofsale.html](http://www.ti.com/legal/termsofsale.html)) or other applicable terms available either on [ti.com](http://ti.com) or provided in conjunction with such TI products. TI's provision of these resources does not expand or otherwise alter TI's applicable warranties or warranty disclaimers for TI products.

Mailing Address: Texas Instruments, Post Office Box 655303, Dallas, Texas 75265  
Copyright © 2020, Texas Instruments Incorporated